

7-5. SEMICONDUCTORS

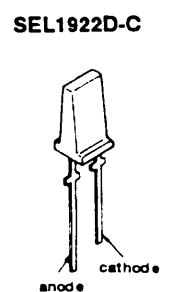

AA3 (R)
CONTRAST AMP
PEDESTAL CLAMP

AA3 (G)
CONTRAST AMP
PEDESTAL CLAMP

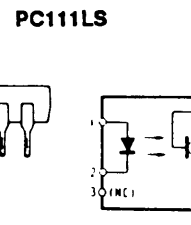
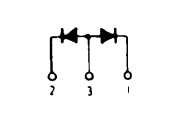
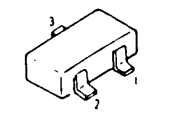
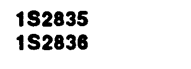
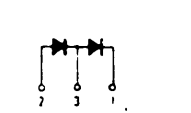
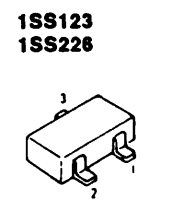
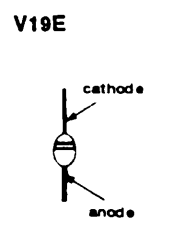
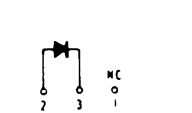
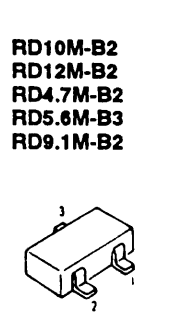
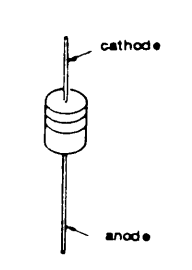
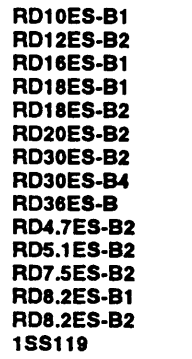
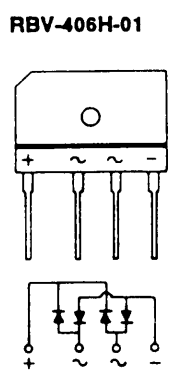
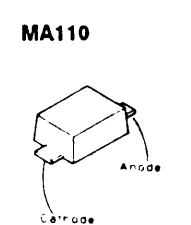
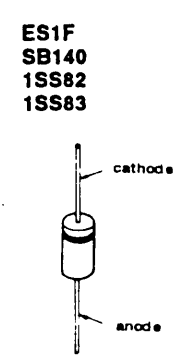
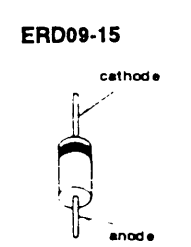
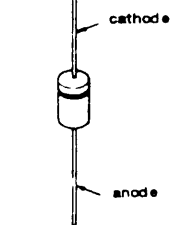
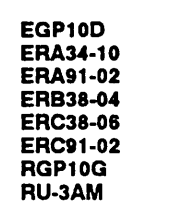
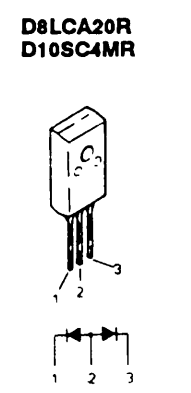
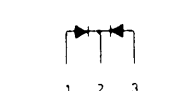
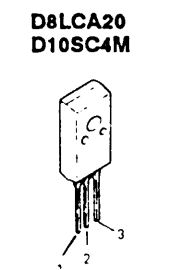
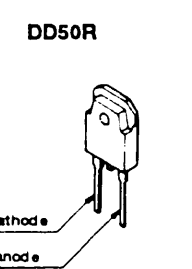
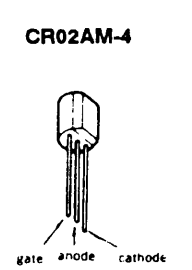
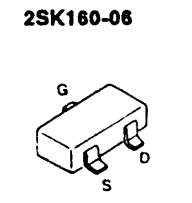
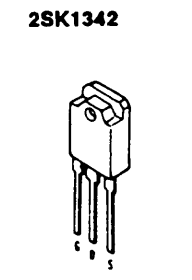
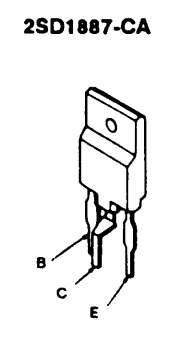
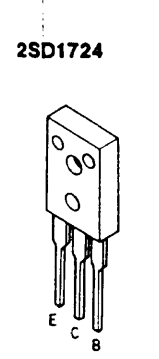
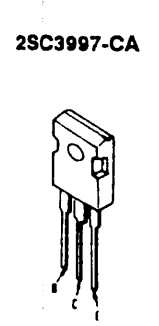
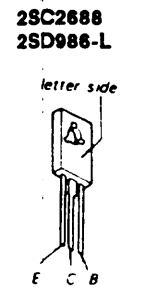
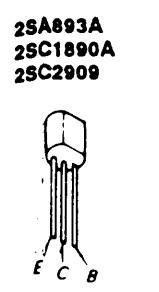
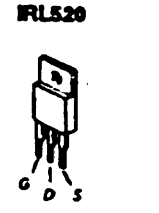
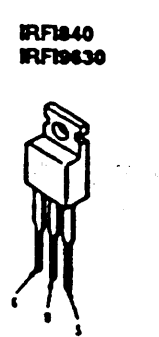
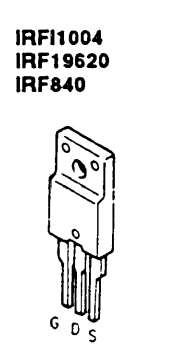
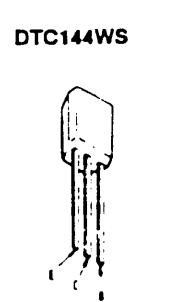
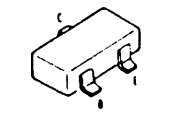
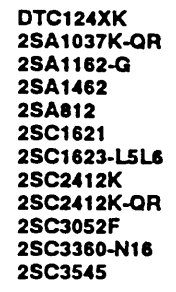
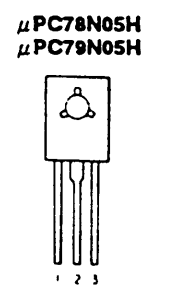
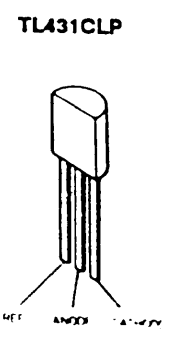
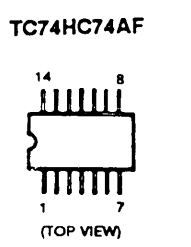
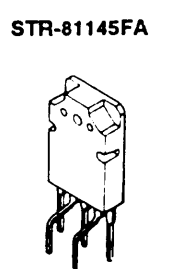
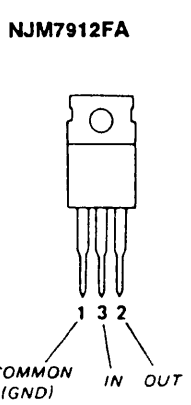
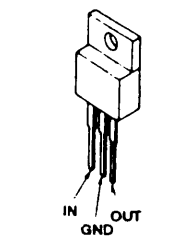
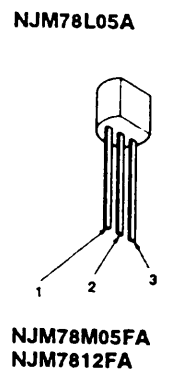
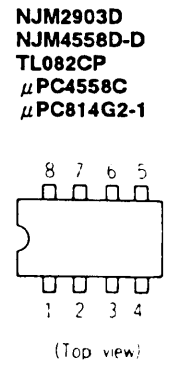
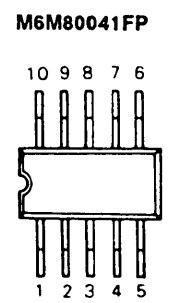
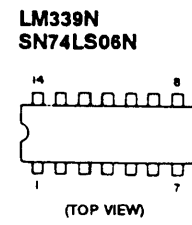
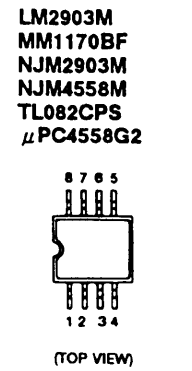
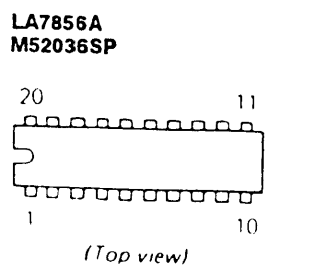
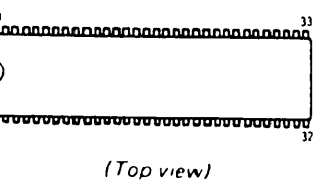
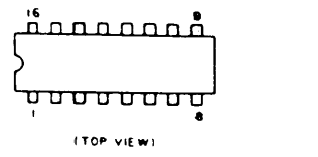
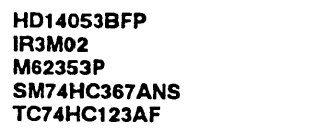
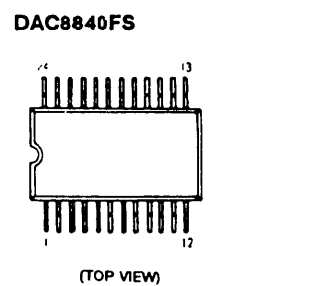
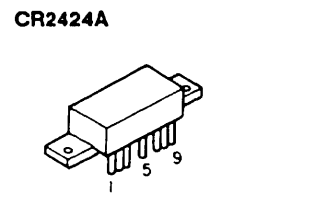
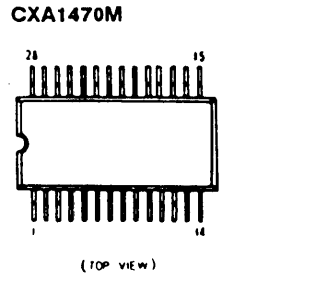
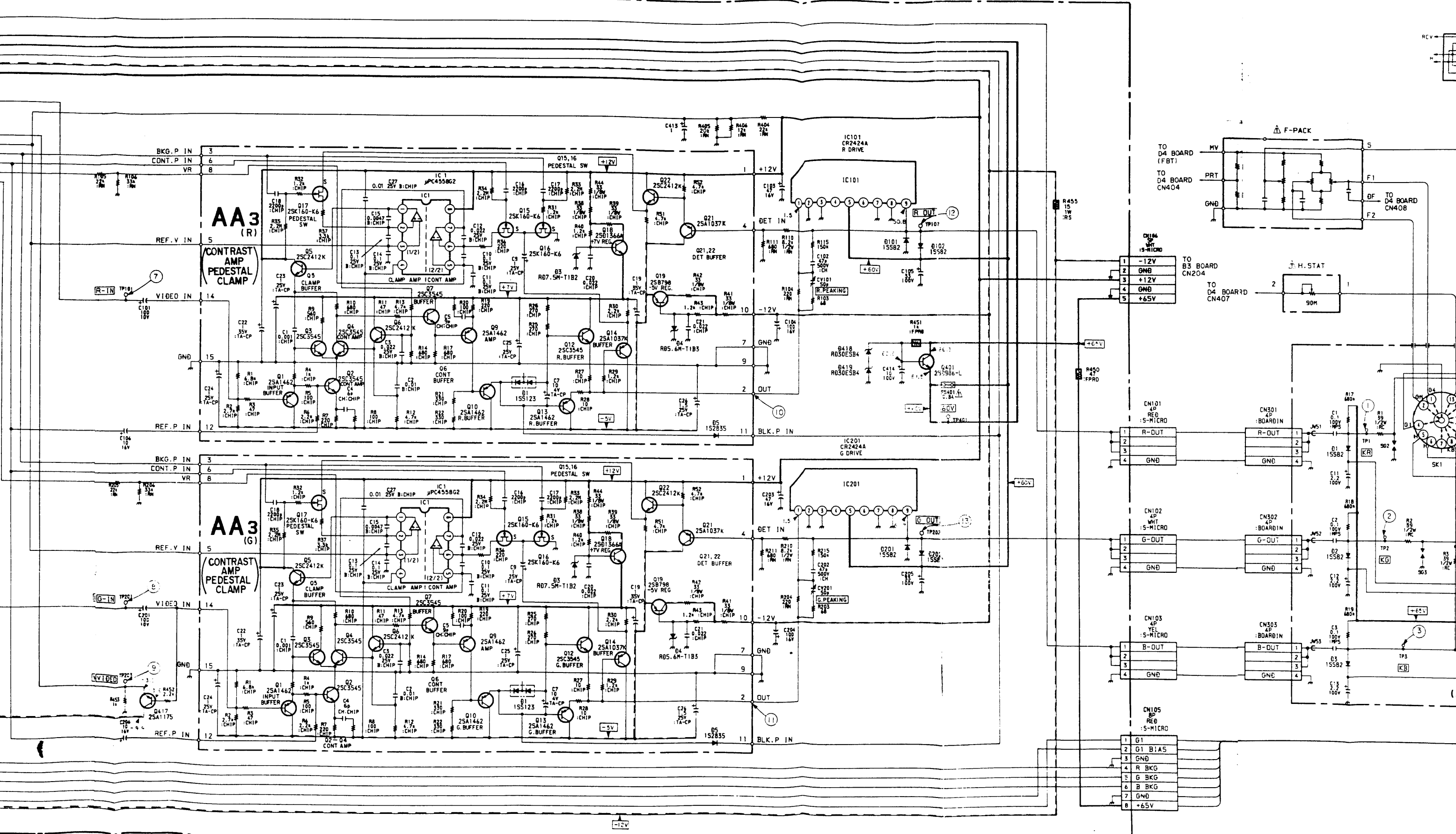

28

29

30

31

32

33

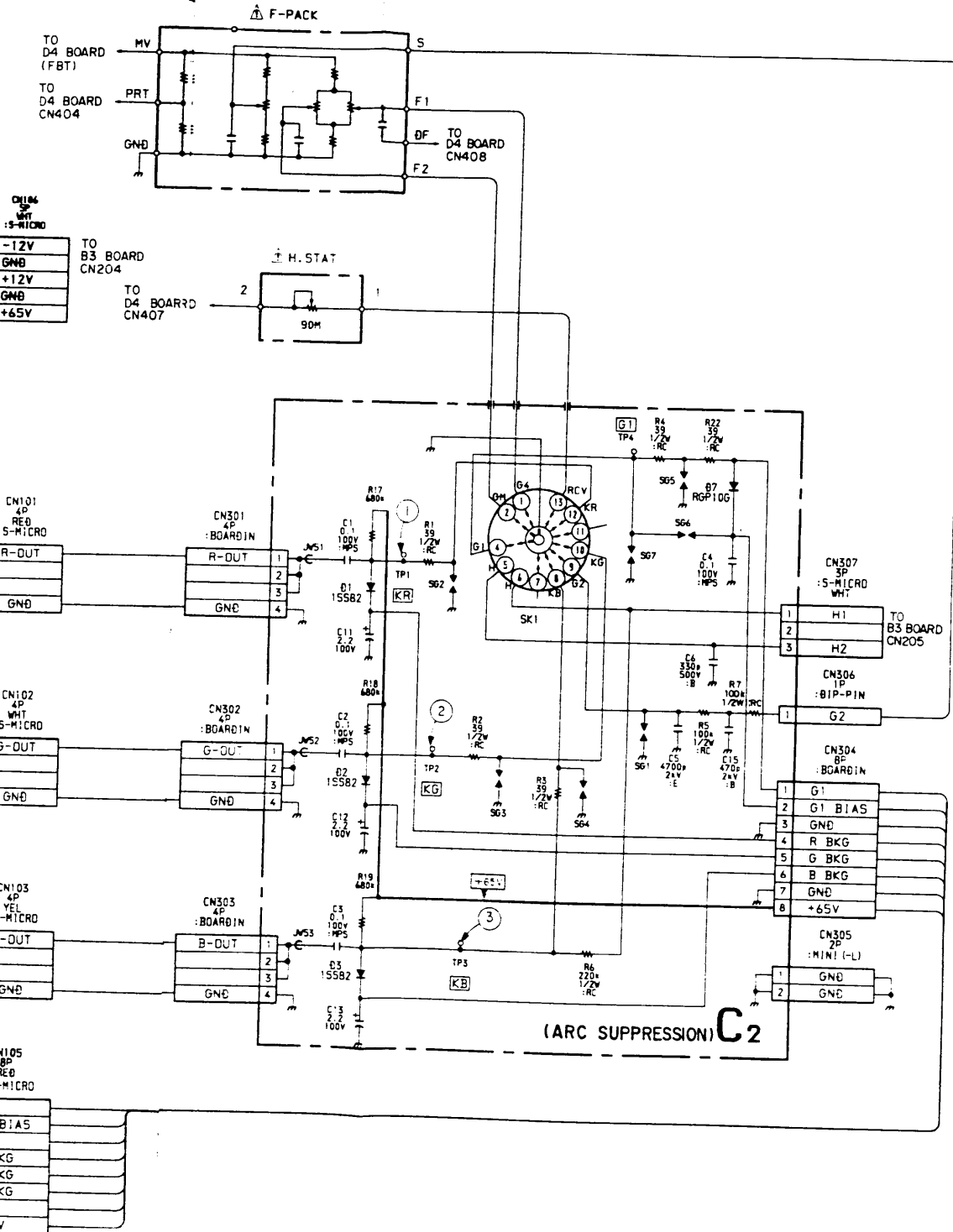
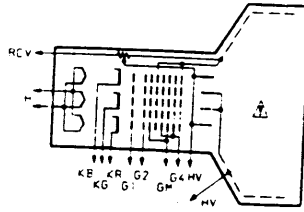

GDM-2039 GDM-2039

1 2 3 4 5 6 7 8 9 10 11 12 13 14 15 16

A
B
C
D
E
F
G
H
I
J

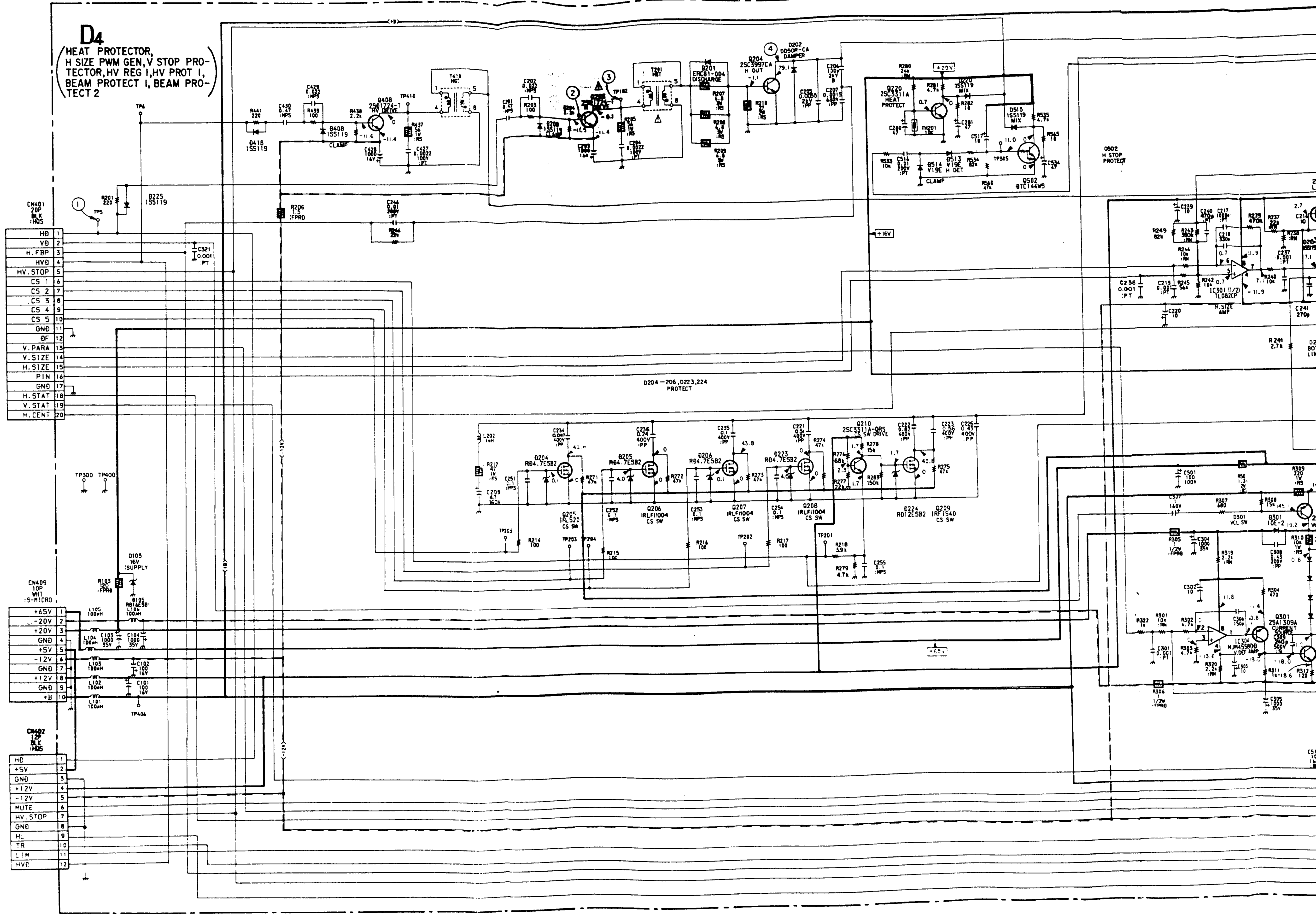

GDM-2039 GDM-2039

15 16 17 18 19 20 21 22 23 24 25 26 27 28 29 30 31

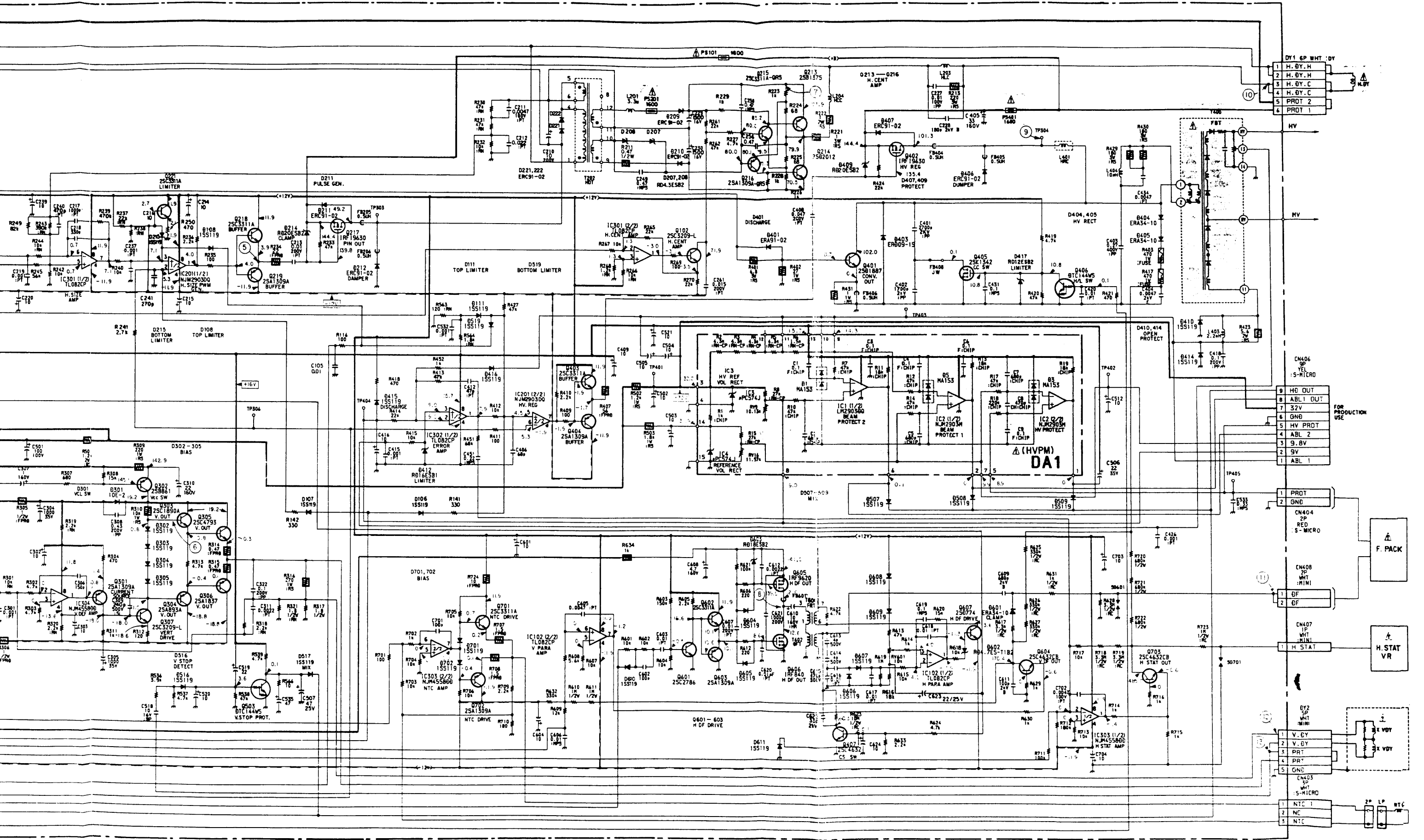

- 1 H. BY. H
- 2 H. BY. H
- 3 H. BY. C
- 4 H. BY. C
- 5 PROT 2
- 6 PROT 1

- 9 HO OUT
- 8 ABL1 OUT
- 7 32V
- 6 GND
- 5 HV PROT
- 4 ABL 2
- 3 9.8V
- 2 9V
- 1 ABL 1

- 1 PROT
- 2 GND

- 1 CN404 2P RED S-MICRO

- 1 DF
- 2 DF

- 1 H STAT

- 1 V. BY
- 2 V. BY
- 3 PRT
- 4 PRT
- 5 GND

- 1 NTC 1
- 2 NC
- 3 NTC

1 2 3 4 5 6 7 8 9 10 11 12 13 14 15 16

A
B
C
D
E
F
G
H
I
J

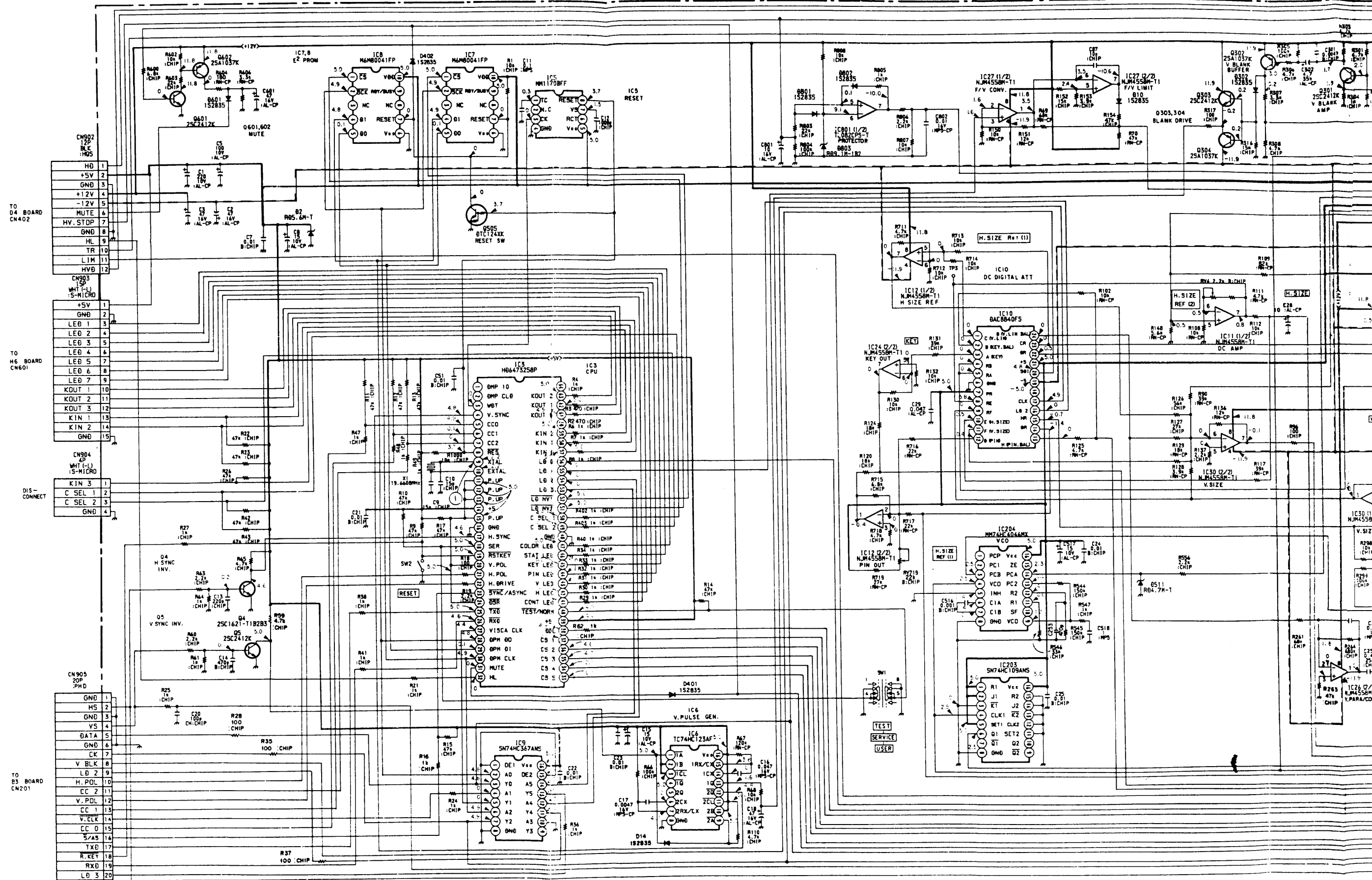

B3 (SYNC PROCESSOR & EMI FILTER)

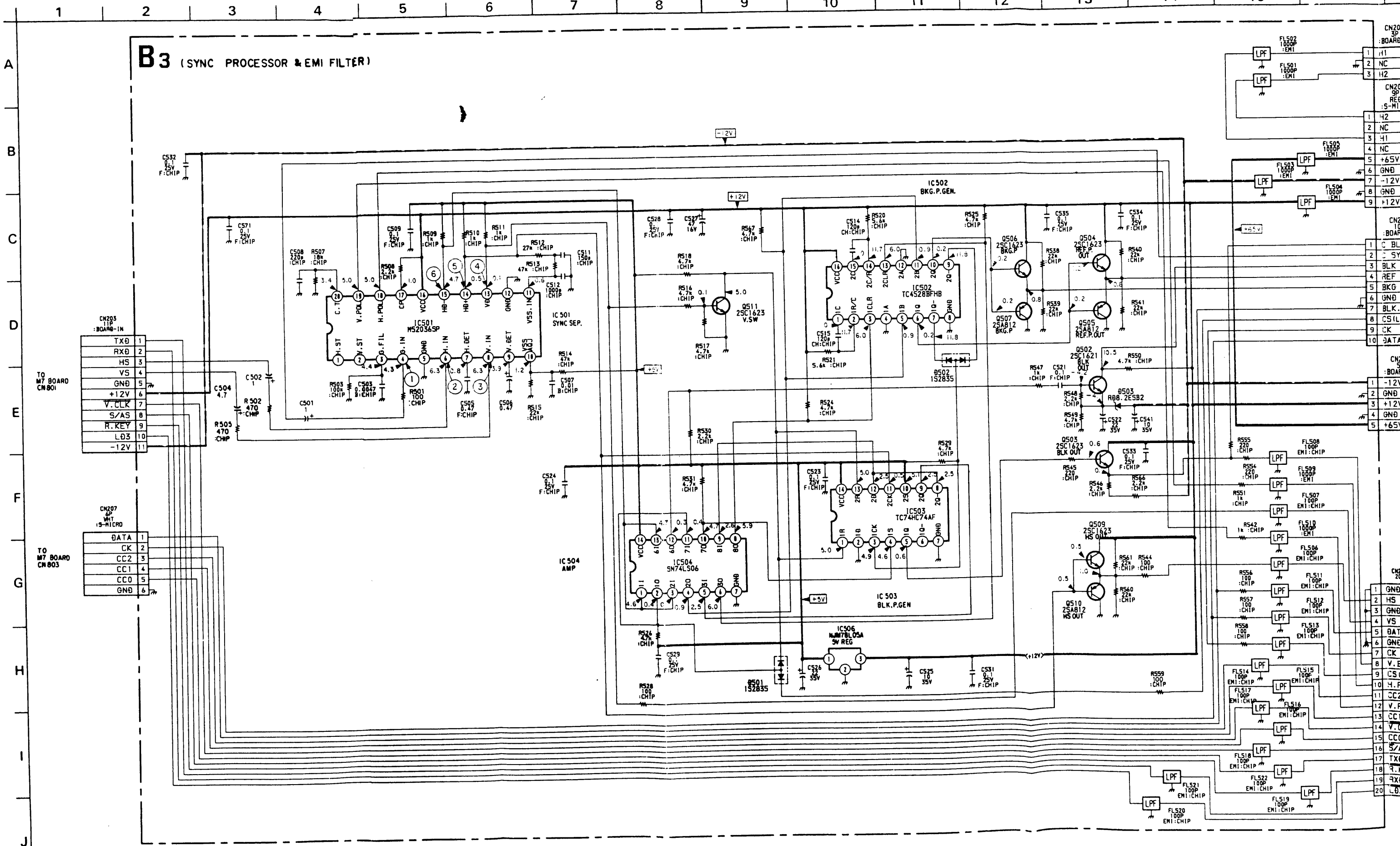

TO M7 BOARD
CN203

TXD	1
RXD	2
HS	3
VS	4
GND	5
+12V	6
V.CLK	7
S/AS	8
R.KEY	9
LD3	10
-12V	11

TO M7 BOARD
CN207

DATA	1
CK	2
CC2	3
CC1	4
CC0	5
GND	6

CN205

1	H1
2	NC
3	H2

CN202

1	H2
2	NC
3	H1
4	NC
5	+65V
6	GND
7	-12V
8	GND
9	+12V

CN206

1	C BLK
2	SYNC
3	BLK P
4	REF P
5	BKG P
6	GND
7	BLK SW
8	CS(LD-2)
9	CK
10	DATA

CN204

1	-12V
2	GND
3	+12V
4	GND
5	+65V

CN201

1	GND
2	HS
3	GND
4	VS
5	DATA
6	GND
7	CK
8	V. BLK
9	CS(LD-2)
10	H. POL
11	CC2
12	V. POL
13	CC1
14	V. CLK
15	CC0
16	S/AS
17	TXD
18	R. KEY
19	RXD
20	LD3

B3

[SYNC PROCESSOR & EMI FILTER]

- B3 BOARD -
(COMPONENT SIDE)

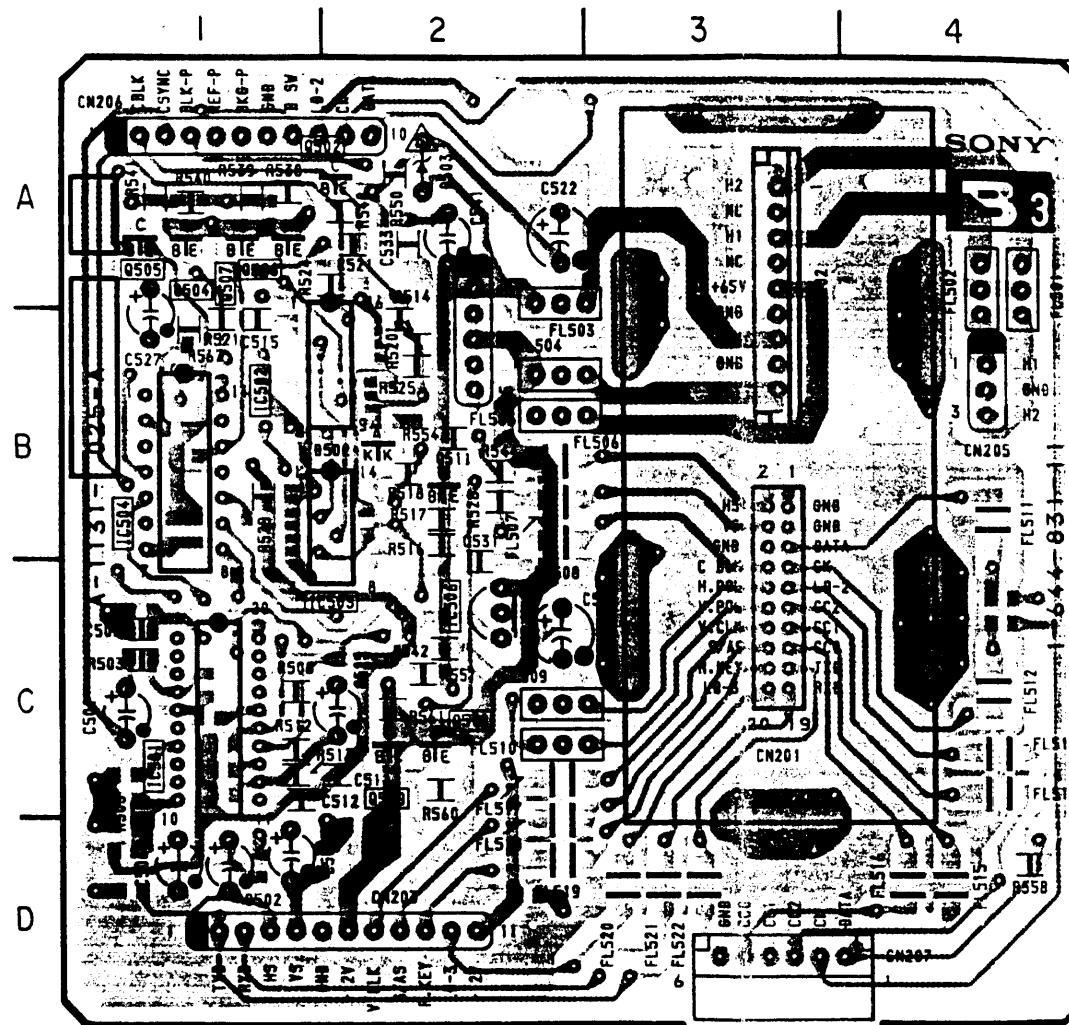

(CONDUCTOR SIDE)

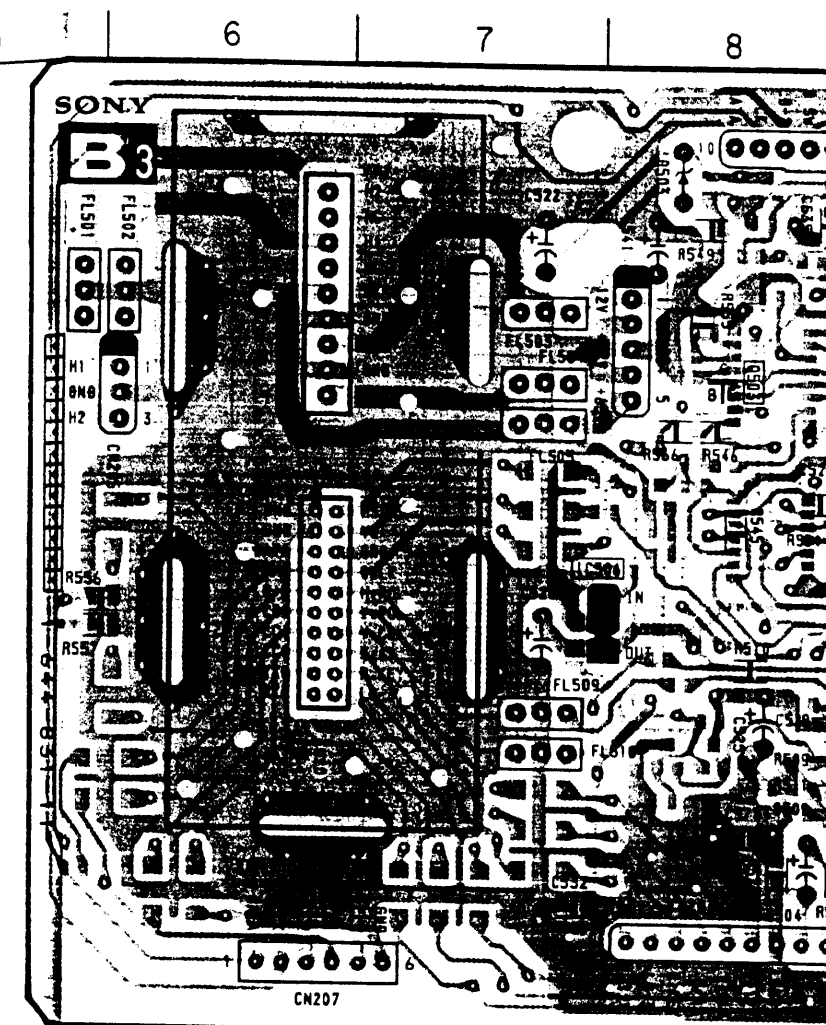

B3 BOARD WAVEFORMS

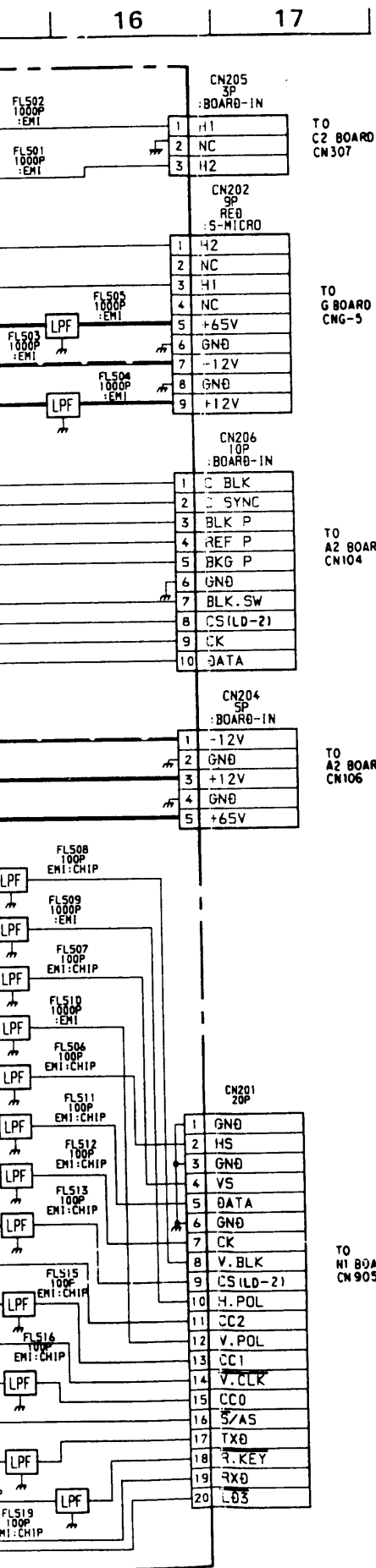
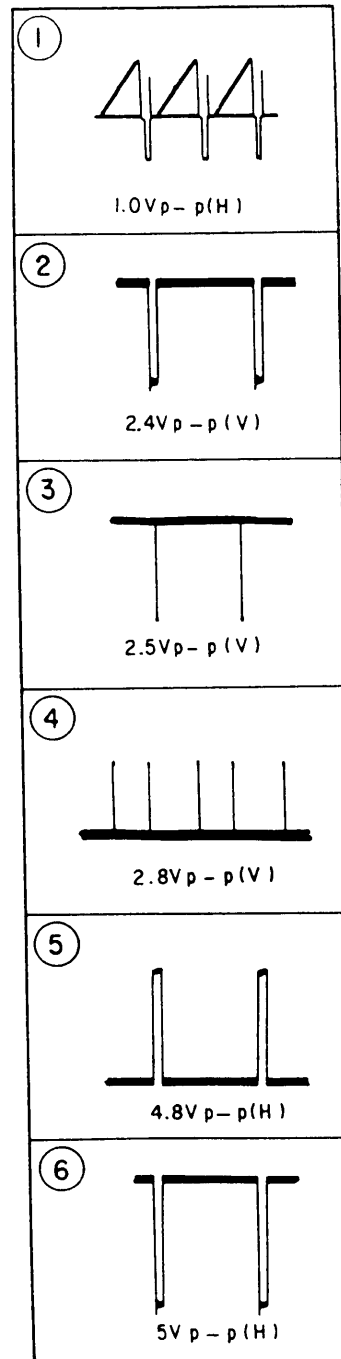

1 2 3 4 5 6 7 8 9 10 11

A
B
C
D
E
F
G
H
I
J

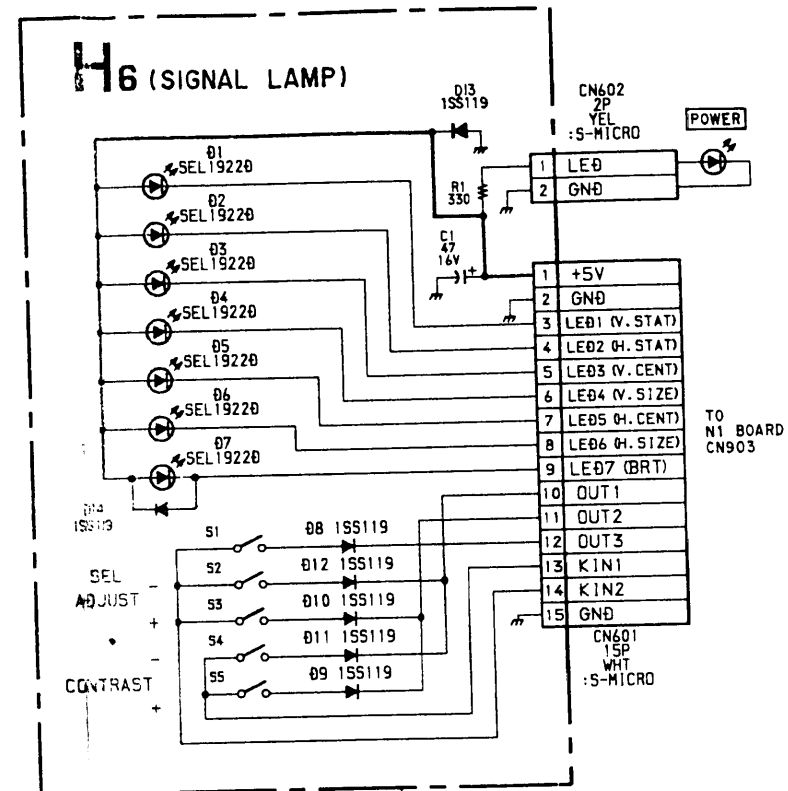
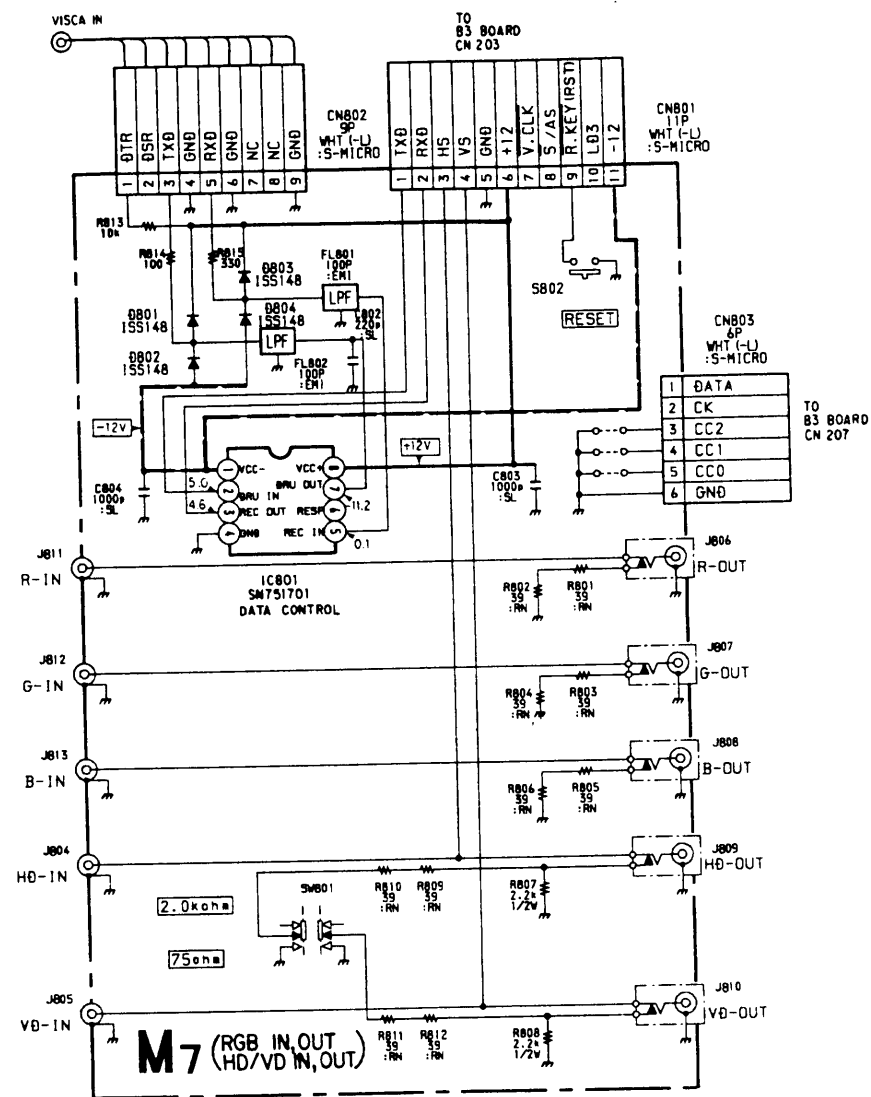

- M7 BOARD -

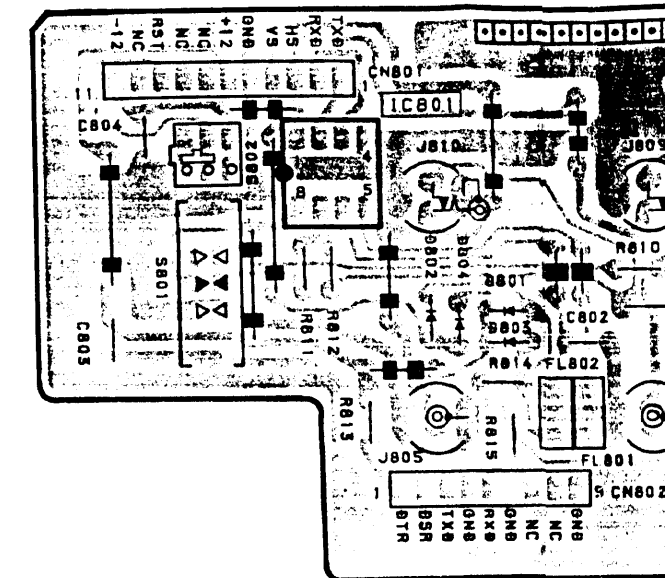

- H6 BOARD -

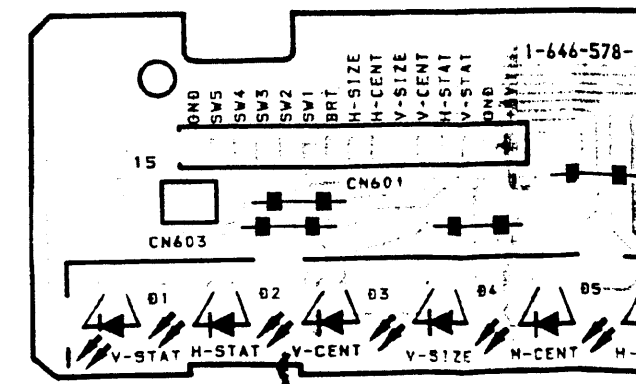

1 2 3 4 5 6 7 8 9 10 11 12 13 14 15

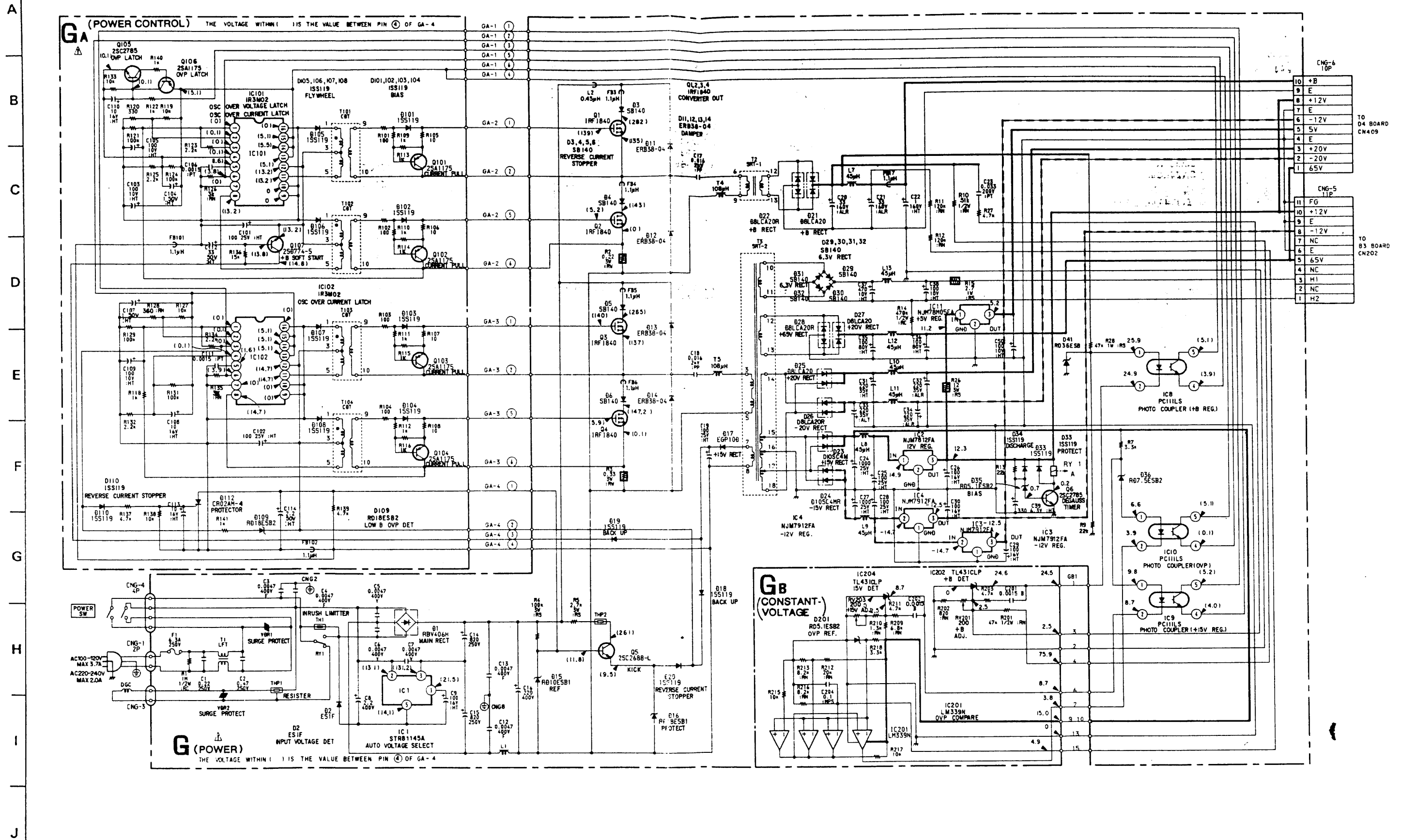

1 2 3 4 5 6 7 8 9 10 11 12 13 14 15 16

A
B
C
D
E
F
G
H
I
J

A2 (VIDEO AMP)

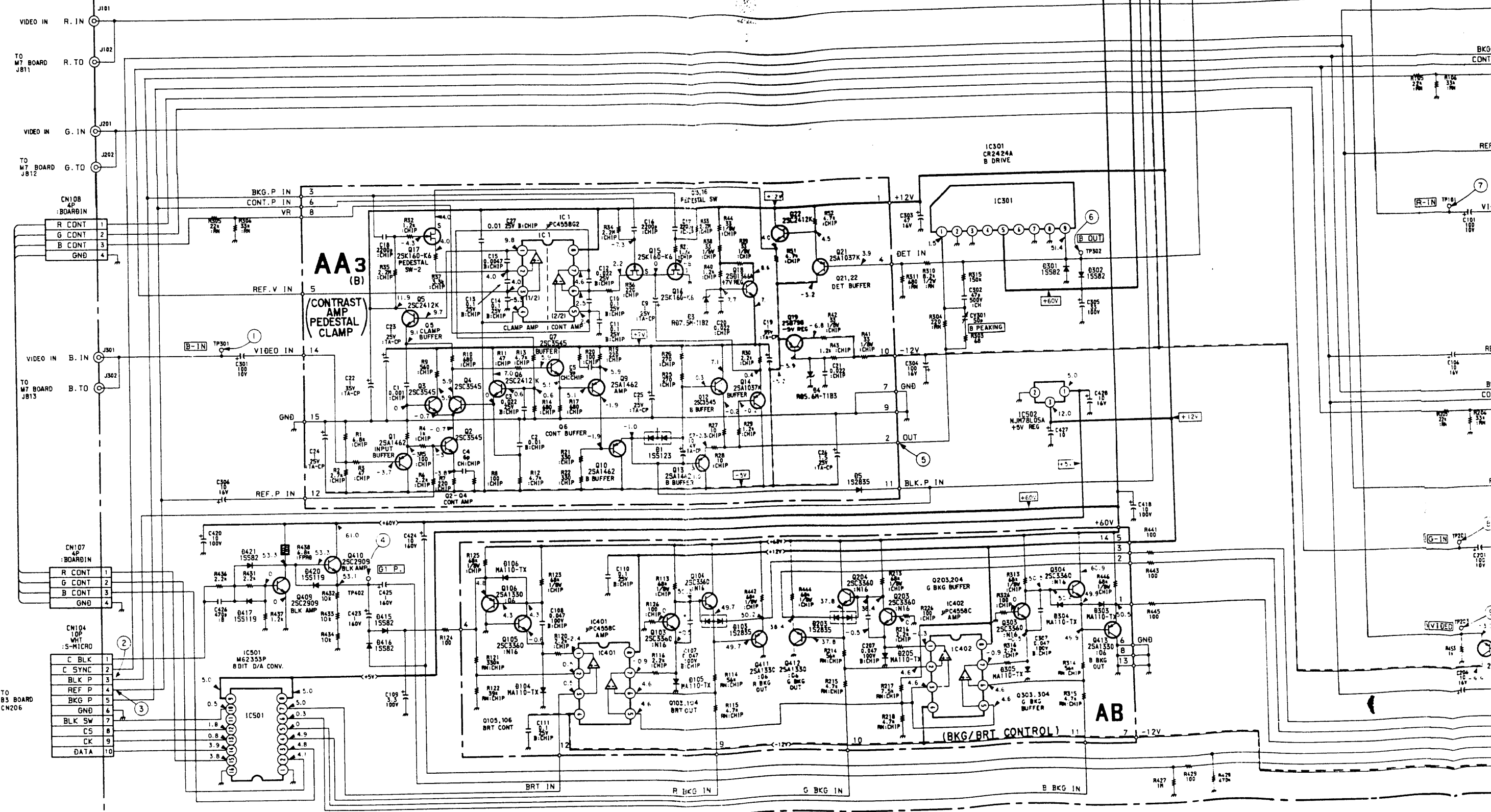

- CN108 4P :BOARD IN
- 1 R CONT
 - 2 G CONT
 - 3 B CONT
 - 4 GND

- CN107 4P :BOARD IN
- 1 R CONT
 - 2 G CONT
 - 3 B CONT
 - 4 GND

- CN104 10P :S-MICRO
- 1 C BLK
 - 2 C SYNC
 - 3 BLK P
 - 4 REF P
 - 5 BKG P
 - 6 GND
 - 7 BLK SW
 - 8 CS
 - 9 CK
 - 10 DATA

TO B3 BOARD CN206