

Service
Service
Service

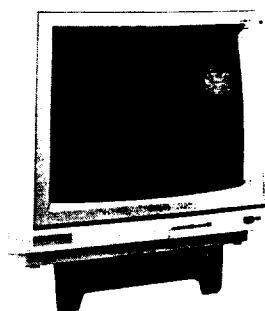

36111 412

Service Manual

1200

(GB)

Mains voltage
Power consumption at 220 Vac
EHT
Loudspeaker impedance
LF output power
Input impedance
Input spec's
CVBS
Sound input
Character display
Picture tube

(NL)

Bedrijfsspanning
Verbruik bij 220 V~
Hoogspanning
Luidspreker impedantie
LF uitgangsvermogen
Ingangsimpedantie
Ingangspecificaties
CVBS
Geluidsingang
Karakter uitlezing
Beeldbuis

(F)

Tension de travail
Consommation à 220 V~
Haute tension
Impédance H.P.
Puissance de sortie BF
Impédance d'entrée
Données d'entrée
CVBS
Entrée son
Affichage caractère
Tube image

220-240 V~
30 W
11.5-12.5 kV
8 Ω
0.3 W
75 Ω

1 V_{tt} ± 0.5 V_{tt}
150 mV-10 kΩ
80x25
M31-344 GH/PC

(D)

Betriebsspannung
Verbrauch bei 220 V~
Hochspannung
Lautsprecherimpedanz
NF-Ausgangsleistung
Eingangsimpedanz
Eingangsspezifikationen
FBAS
Toneingang
Zeichenauslesung
Bildröhre

(I)

Tensione rete
Consumo rete a 220 V~
EAT
Impedenza altoparlante
Potenza uscita BF
Impedenza ingresso
Dati d'ingresso
CVBS
Ingresso suono
Display carattere
Cinescopio

220-240 V~
30 W
11.5-12.5 kV
8 Ω
0.3 W
75 Ω

1 V_{tt} ± 0.5 V_{tt}
150 mV-10 kΩ
80x25
M31-344 GH/PC



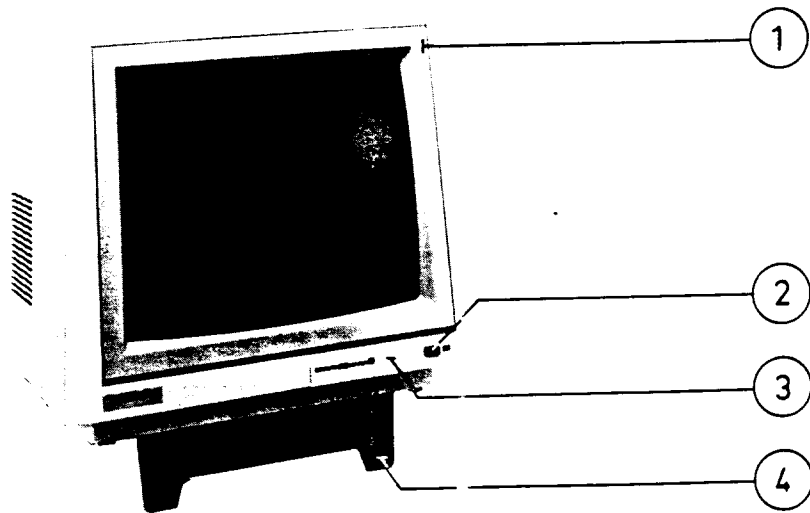

36 106 A12

- | | | |
|---|----------------|-------------------------------|
| 1 | 4822 430 70297 | Cabinet |
| 2 | 4822 276 11161 | On/off switch |
| 3 | 4822 432 91575 | Cover for adjustment unit |
| 4 | 4822 462 10232 | Foot |
| | 4822 466 91437 | Block for AC-cord --00G |
| | 4822 466 91497 | Block for AC-cord - 05G |
| | 4822 410 23595 | Knob for on. off switch |
| | 4822 535 70797 | Adjust rod for S523 |
| | 4822 535 91695 | Adjust rod for R406-R425-R503 |

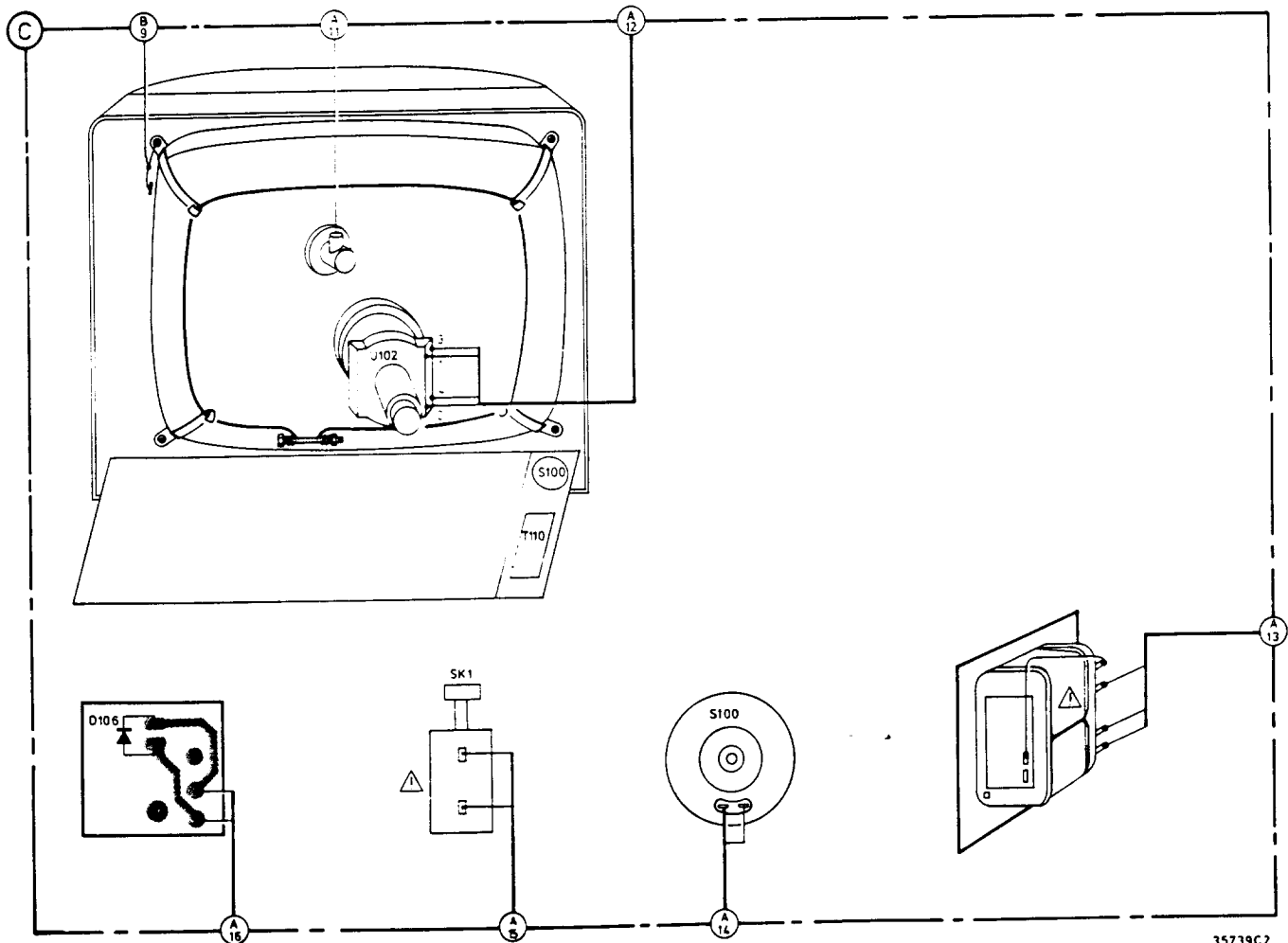

35739C2

CS 96 366

NL OPMERKINGEN

1. De gelijkspanningen, die in het principeschema zijn aangegeven, zijn gemiddelde spanningen. Ze zijn gemeten onder de volgende condities:
 - Helderheidsregelaar op minimum
 - Kontrastregelaar op maximum
2. De oscillogrammen zijn onder de volgende condities gemeten:
 - Signaal van een patroongenerator op stand grijschaal, Video output instellen op 0.4 Vpp (PM5519).
 - Helderheidsregelaar op maximum.
 - Kontrastregelaar op maximum.
3. Defecte veiligheidsweerstanden moeten worden vervangen door het type, dat in de elektrische stuklijst is aangegeven.
Veiligheidsweerstanden worden aangeduid met het symbool .
4. Tijdens het vervangen van de beeldbuis wordt een veiligheidsbril voorgeschreven.
5. Veiligheidsbepalingen vereisen dat het apparaat in zijn oorspronkelijke toestand wordt teruggebracht en dat onderdelen, identiek aan de oorspronkelijke worden toegepast.
6. De halfgeleiders, die in het principeschema en in de stuklijst zijn vermeld, zijn per positie in dit chassis volledig uitwisselbaar met de halfgeleiders in het apparaat, ongeacht de typeaanduiding op deze halfgeleiders.

MECHANISCHE INSTRUKTIES

Uitnemen van het chassis

- Verwijder de achterwand.
- Het chassis kan nu uitgeschoven worden.
- Verwijder de schroeven van de net trafo zodat deze, indien gewenst, ook uitgeschoven kan worden.
- Na de reparatie moeten de verbindingskabels van het chassis op de originele manier worden vastgezet.

INSTELLINGEN

1 Voedingsspanning

- Sluit een voltmeter aan op kollektor TS101 (+11).
- Stel R106 zodanig in dat de voltmeter 11 V aanwijst.

2 Horizontale tijdbasis

- Breng een kortsluiting aan tussen C503/R504 en massa.
- Stel R513 zo in, dat het beeld rechtop staat.
- Verwijder de kortsluiting.

3 Focusering

Optimale instelling van de focusering kan bereikt worden met R336.

4. Helderheidsvoorinstelling

- Zet een signaal op de video ingang.
- Helderheidsregelaar op maximum (R332).
- Contrast regelaar op minimum (R303).
- Stel de helderheidsvoorinstelling R331 zo in dat er net geen terugslag lijnen zichtbaar zijn.

F REMARQUES

1. Les tensions continues qui sont données au schéma de principe, sont des tensions moyennes. Elles ont été prélevées dans les conditions suivantes:
 - La commande de luminosité au minimum
 - La commande de contraste au maximum
2. Les oscillogrammes ont été prélevées dans les conditions suivantes:
 - Appliquer le signal d'un générateur de mire en position échelle des gris: sortie vidéo à 0.4 Vtt (PM5519).
 - Commande de luminosité au maximum.
 - La commande de contraste au maximum.
3. Les résistances de sécurité défectueuses doivent être remplacées par le type donnée dans la liste des pièces électriques et symbolisé par .
4. Le port de lunettes protectrices est obligatoire lors du remplacement du tube image.
5. Les normes de sécurité exigent, qu'après réparation l'appareil soit remis à son état d'origine et que les composants utilisés soient identiques aux originaux.
6. Les semi-conducteurs dans le schéma de principe et à la liste des composants, sont interchangeables par repère sur ce châssis avec le semi-conducteurs de l'appareil quelle que soit la désignation de type donnée sur ces semi-conducteurs.

INSTRUCTIONS D'ORDRE MECANIQUE

1. Retirer du châssis

- Retirer le panneau arrière.
- Le châssis peut à présent être glissé au dehors.
- Enlever les vis du transfo secteur pour qu'il puisse au besoin être glissé au dehors.
- Après la réparation, les câbles de liaison du châssis devront être fixés comme à l'origine.

REGLAGES

1 Tension d'alimentation

- Brancher un voltmètre au collecteur de TS101 (+11).
- Régler R106 pour que le voltmètre affiche 11 V.

2 Base de temps horizontale

- Provoquer un court-circuit entre C503/R504 et le masse.
- Régler R513 pour que l'image soit parfaitement verticale.
- Éliminer le court-circuit.

3 Focalisation

Le réglage optimal de la focalisation est obtenu grâce à R336.

4. Préréglage luminosité

- Appliquer un signal sur l'entrée vidéo.
- Commande de luminosité au maximum (R332).
- Commande de contraste au minimum (R303).
- Ajuster le préréglage de luminosité R331 de manière qu'il n'y ait pas de retour ligne visible.

D ANMERKUNGEN

1. Die im Prinzipschaltbild erwähnten Gleichspannungen sind Durchschnittsspannungen. Sie wurden unter folgenden Bedingungen gemessen:
 - Helligkeitsregler auf Minimum
 - Kontrastregler auf Maximum
2. Die Oszillogramme wurden unter folgenden Bedingungen gemessen:
 - Signal von einem Mustergenerator in Stellung Grauskala;
 - Video-Ausgang auf $0,4 V_{SS}$ (PM5519) einstellen.
 - Helligkeitsregler auf Maximum.
 - Kontrastregler auf Maximum.
3. Mangelhafte Sicherheitswiderstände sind auszuwechseln gegen den Type, der in der elektrischen Stückliste vermerkt ist. Sicherheitswiderstände werden mit dem Symbol  gekennzeichnet.
4. Beim Auswechseln der Bildröhre muss eine Schutzbrille getragen werden.
5. Sicherheitsbestimmungen erfordern, dass das Gerät in die ursprüngliche Lage zurückgebracht wird, und dass Bauteile plaziert werden, die den ursprünglichen entsprechen.
6. Die im Prinzipschaltbild und in der Stückliste aufgeführten Halbleiter sind positionsweise in diesem Chassis völlig auswechselbar gegen die Halbleiter im Gerät, ungeachtet der Typenbezeichnung auf diesen Halbleitern.

MECHANISCHE ANWEISUNGEN

1. Herausnehmen des Chassis

- Rückwand abnehmen.
- Das Chassis lässt sich nun herauschieben.
- Die Schrauben am Netztransformator lösen, so dass er sich bei Bedarf ebenfalls herauschieben lässt.
- Nach der Reparatur müssen die Verbindungskabel des Chassis in der ursprünglichen Weise fixiert werden.

EINSTELLUNGEN

1. Versorgungsspannung

- Ein Voltmeter an den Kollektor von TS101 (-11) schalten.
- R106 dahin einstellen, dass das Voltmeter 11 V anzeigt.

2. Horizontale Zeitbasis

- Masseschluss mit C503/R504 herstellen.
- R513 dahin einstellen, dass das Bild aufrecht steht.
- Masseschluss beheben.

3. Fokussierung

Die möglichst günstige Einstellung der Fokussierung lässt sich mit R336 erzielen.

4. Helligkeitsvoreinstellung

- Ein Signal auf den Video-Eingang geben.
- Helligkeitsregler auf Höchstwert (R332).
- Kontrastregler auf Mindestwert (R303).
- Helligkeitsvoreinstellung mit R331 so einstellen, dass gerade keine Rücklaufzeilen sichtbar sind.

I NOTE

1. La tensioni continue riportate sullo schermo elettrico sono tensioni medie misurate nelle seguenti condizioni:
 - Luminosità al minimo e contrasto al massimo.
2. Gli oscillogrammi sono stati misurati con:
 - Regolare il generatore di segnale in posizione scala dei grigi, uscita video a $0,4 V_{CC}$ (PM5519).
 - Contrasto al massimo.
 - Luminosità al massimo.
3. Le resistenze di sicurezza difettose devono essere sempre sostituite col tipo originale specificato sulla lista dei componenti elettrici. Il simbolo di tali resistenza è .
4. In caso di sostituzione del cinescopio usare opportuni occhiali di protezione.
5. Per motivi di sicurezza è necessario riportare il televisore sempre allo stato originale. E' pertanto indispensabile usare le parti di ricambio identiche a quelle sostituite.
6. Il televisore può montare semiconduttori non menzionati né sullo schema elettrico né sulla lista delle parti di ricambio. Chiaramente però tali semi-conduttori sono perfettamente intercambiabili con quelli originali.

ISTRUZIONI MECCANICHE

1. Rimozione del telaio.

- Levare il pannello posteriore.
- Sfilare verso l'esterno il telaio.
- Togliere le viti dal trasformatore in modo che questo possa essere scivolato se necessario.
- Dopo riparazioni i cavi di collegamento del telaio dovranno essere fissati in modo originale.

REGOLAZIONI

1. Tensione di alimentazione

- Collegare un voltmetro al collettore di TS101 (-11).
- Regolare R106 per una lettura di 11 V.

2. Base dei tempi (sincronizzazione) orizzontale

- Cortocircuitare fra C503/R504 a massa.
- Regolare R513 per ottenere un'immagine verticale stazionaria.
- Togliere il cortocircuito.

3. Focalizzazione

La regolazione ottimale del fuoco viene eseguita tramite R336.

4. Preregolazione luminosità

- Fornire un segnale in ingresso sul video.
- Comando di luminosità al massimo (R332).
- Comando di contrasto al minimo (R303).
- Predisporre la preregolazione di luminosità R331 in modo che non vi sia visibile il ritorno riga.

GB NOTES

- The DC voltages specified in the circuit diagram are average voltages. They have been measured while:
 - Brightness had been adjusted to minimum and contrast to maximum.
- The oscillograms have been measured while:
 - A signal from a pattern generator in grey scale position; adjust video output for 0.4 V_{pp} (PM5519).
 - Brightness had been adjusted to maximum. Contrast had been adjusted to maximum.
- Defective safety resistors must be replaced by the types specified in the list of electrical parts. These resistors are labelled with the symbol: .
- When the picture tube is being replaced, safety glasses must be worn.
- Safety regulations require that the receiver be restored to its original state and that therefore components are used which are identical with the components replaced.
- The semi-conductors mentioned in the circuit diagram and the parts list, and the semi-conductors in the receiver are interchangeable per item in this chassis irrespective of the type designation on these semi-conductors.

MECHANICAL INSTRUCTIONS

1. Removing the chassis

- Remove the backcover.
- Slide out the chassis.
- Remove the screws of the mains transformer so that, if desired, this can be slid out as well.
- After repair the connecting cables of the chassis should be fixed in the original way.

ADJUSTMENTS

1 Supply voltage

- Connect a voltmeter to the collector of TS101 (-11).
- Adjust R106 until the voltmeter indicates 11 V.

2 Horizontal time base

- Short circuit C503/R504 and earth.
- Adjust R513 until the picture is vertical.
- Remove the short circuit.

3 Focusing

Optimum adjustment of focusing can be realized with R336.

4. Preliminary brightness adjustment

- Apply a signal to the video input.
- Brightness control to maximum (R332).
- Contrast control to minimum (R303).
- Adjust preliminary brightness adjustment R331 until the flyback lines are just not visible.

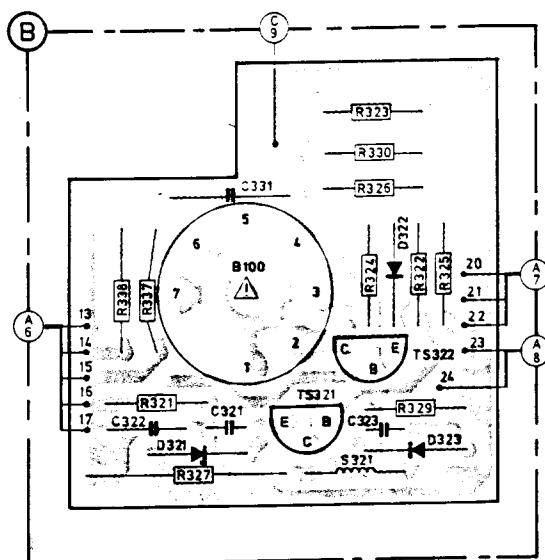

35732 B2

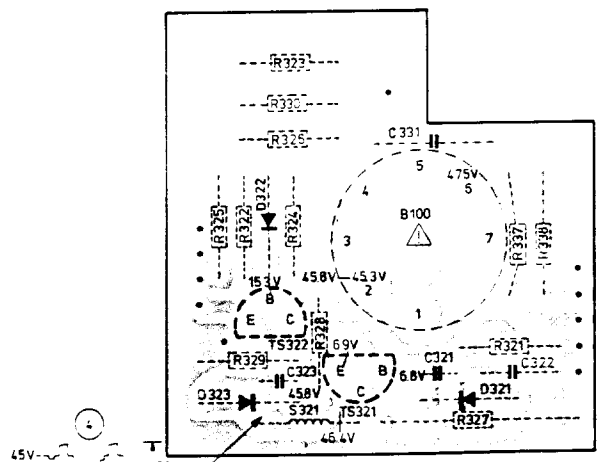

35835 B

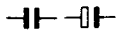

C102	4822 122 31989	2.2 nF - 100 V
C103	4822 122 31989	2.2 nF - 100 V
C104	4822 124 21502	4700 μ F - 25 V
C105	4822 122 32156	100 pF - 50 V
C201	4822 122 32156	100 pF - 50 V
C204	4822 122 32157	820 pF - 50 V
C342		15 nF - 63 V
C423	4822 122 32157	820 pF - 50 V
C432	4822 122 32156	100 pF - 50 V
C513	4822 121 50538	6.8 nF - 63 V
C527	4822 124 21379	4.7 μ F - 160 V
C528	4822 121 42111	15 nF - 400 V

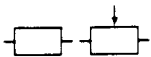

R106	4822 100 10236	4.7 k Ω - lin
R202	4822 100 30045	470 k Ω - log
R203	4822 111 30517	22 Ω - safety
R212	4822 111 30506	8.2 Ω - safety
R303	4822 100 20121	470 Ω - lin
R315	4822 111 30524	39 Ω - safety
R327	5322 116 54403	1 k Ω
R328	4822 110 43098	470 Ω
R331	4822 100 10103	1 M Ω - lin
R332	4822 100 20122	470 k Ω - lin
R336	4822 101 20727	2 M Ω
R337	4822 111 50482	33 k Ω
R338	4822 111 50482	33 k Ω
R406	4822 101 10547	10 k Ω - lin
R423	4822 100 10076	47 k Ω - lin
R425	4822 101 10548	330 k Ω - lin
R503	4822 101 10269	47 k Ω
R513	4822 100 20054	330 Ω
R523	4822 111 30506	8.2 Ω - safety
R526	4822 111 30561	1 k Ω - safety
R527	4822 111 30502	5.6 Ω - safety
R528	4822 111 30535	100 Ω - safety



S321	4822 158 10594
T521	4822 150 50051
T522	4822 140 10262
S523	4822 157 51717
S524	4822 157 51914



1N4003	4822 130 31174
GP15D	4822 130 31173
BZX79-C6V2	4822 130 34167
BZX79-C6V8	4822 130 34278
BZX79-C12	4822 130 34197
BZX79-C24	4822 130 34398
BZX79-C20	4822 130 34499
BZV85-C51V	4822 130 32338
BA317	4822 130 30847
1N4148	4822 130 30621
RGP15G	4822 130 31168
BYV96E	5322 130 34979
BAV21	4822 130 34189
BA157	4822 130 41487
CQW11B	4822 130 42242



BC548C	4822 130 44196
BC549C	4822 130 44246
BC558B	4822 130 44197
BC559B	4822 130 44358
BC328	4822 130 44104
BC338	4822 130 44121
BC635	5322 130 44349
BC636	4822 130 44283
BC637	4822 130 41041
BF422	4822 130 41782
BU406	4822 130 42241
BD202/BD534L	5322 130 44324

Various

U102	4822 150 10188	Deflection unit
S100	4822 240 30266	Loudspeaker
T110-00G	4822 146 30491	Mains trafo
T110-05G	4822 146 30493	Mains trafo
VL110	4822 252 20007	Thermal fuse
VL102	4822 253 30025	Fuse T2A
	4822 267 20241	RCA jack
	4822 255 70189	CRT socket
	4822 265 20235	Micro connector

GB

Safety regulations require that the set be restored to its original condition and that parts which are identical with those specified be used.

NL

Veiligheidsbepalingen vereisen, dat het apparaat in zijn oorspronkelijke toestand wordt teruggebracht en dat onderdelen, identiek aan de gespecificeerde, worden toegepast.

F

Les normes de sécurité exigent que l'appareil soit remis à l'état d'origine et que soient utilisées les pièces de rechange identiques à celles spécifiées.

D

Bei jeder Reparatur sind die geltenden Sicherheitsvorschriften zu beachten. Der Originalzustand des Geräts darf nicht verändert werden; für Reparaturen sind Original-Ersatzteile zu verwenden.

I

Le norme di sicurezza esigono che l'apparecchio venga rimesso nelle condizioni originali e che siano utilizzati i pezzi di ricambio identici a quelli specificati.

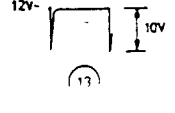
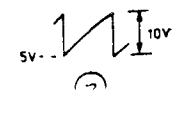
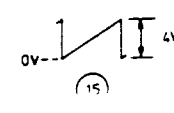
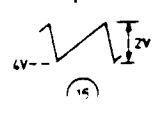
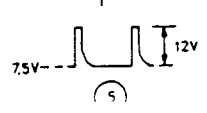
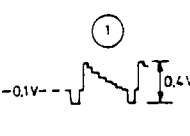
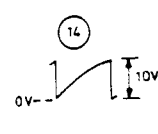
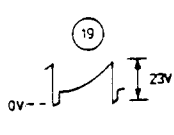
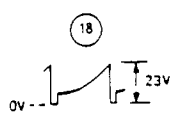
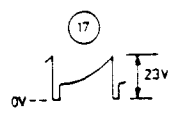
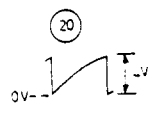
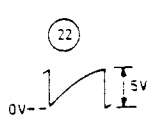
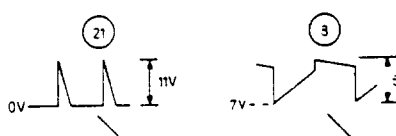
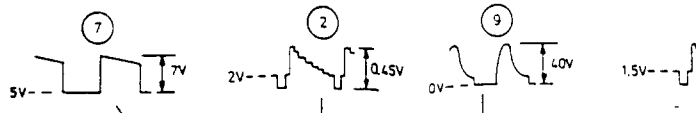
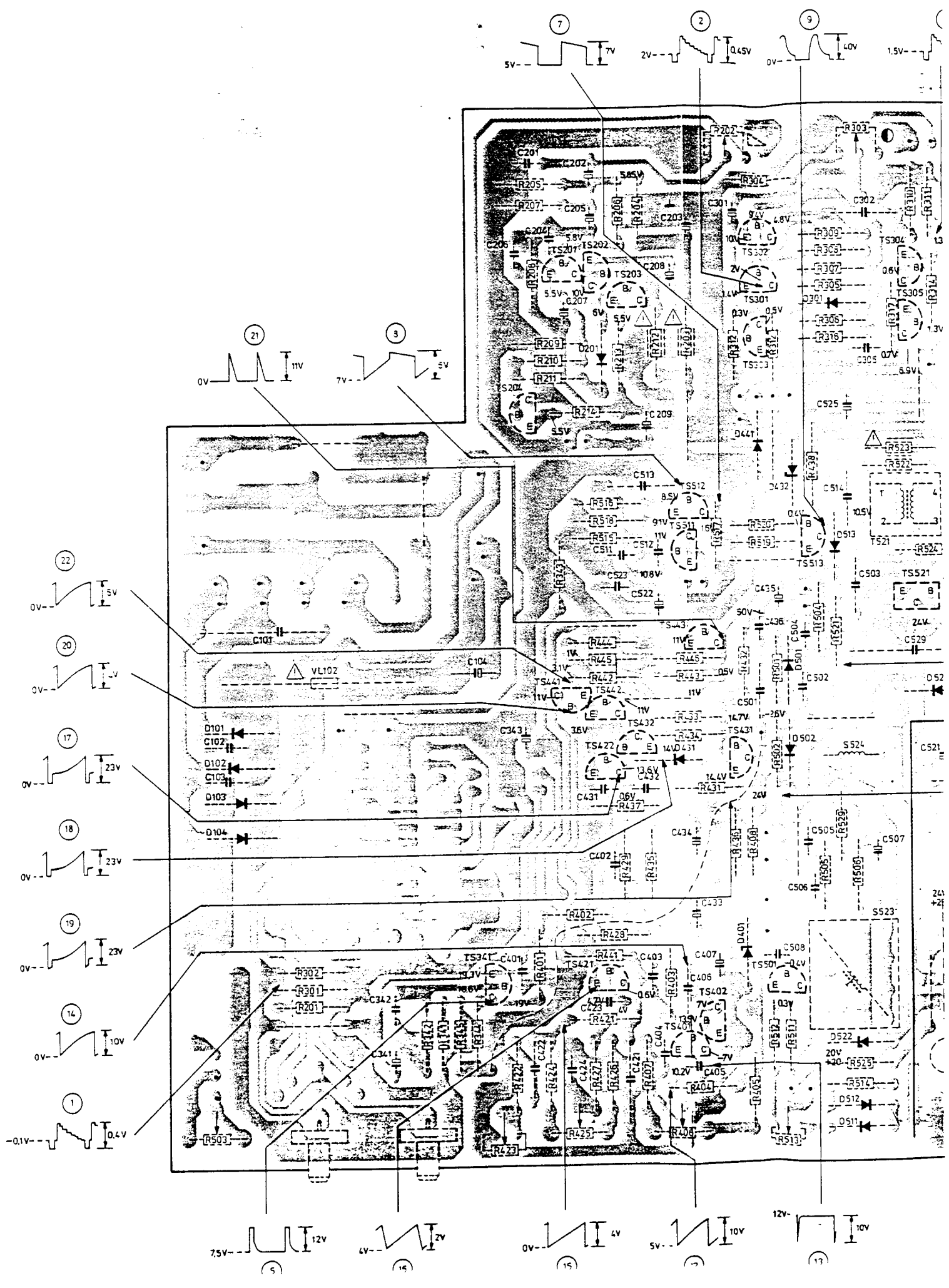

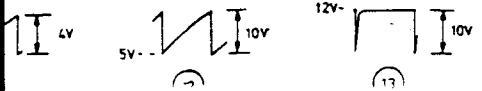
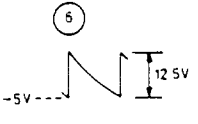
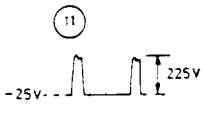
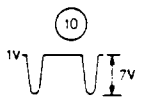
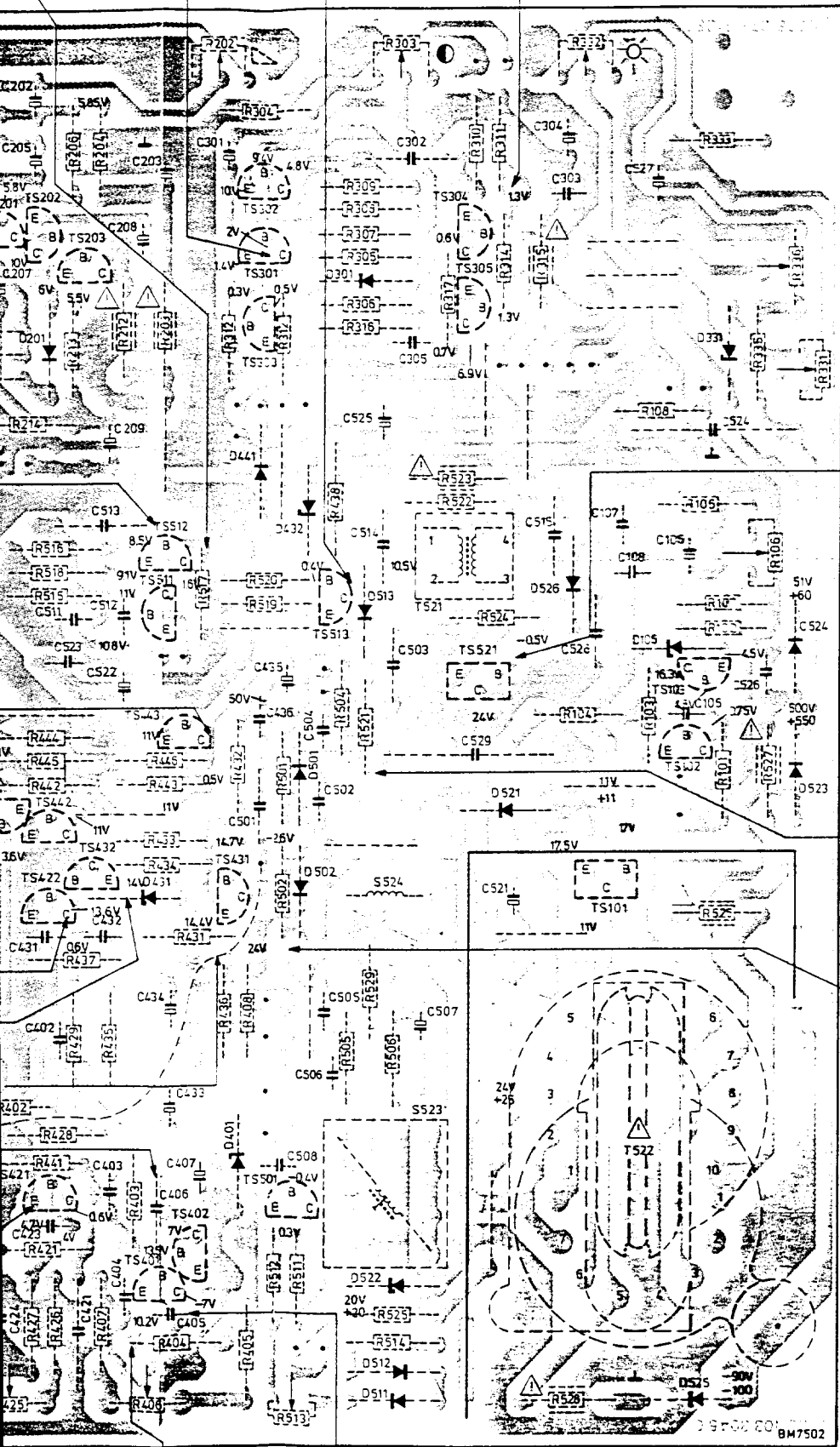
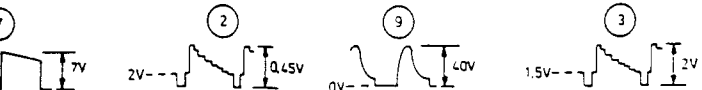

35833017

BM7502

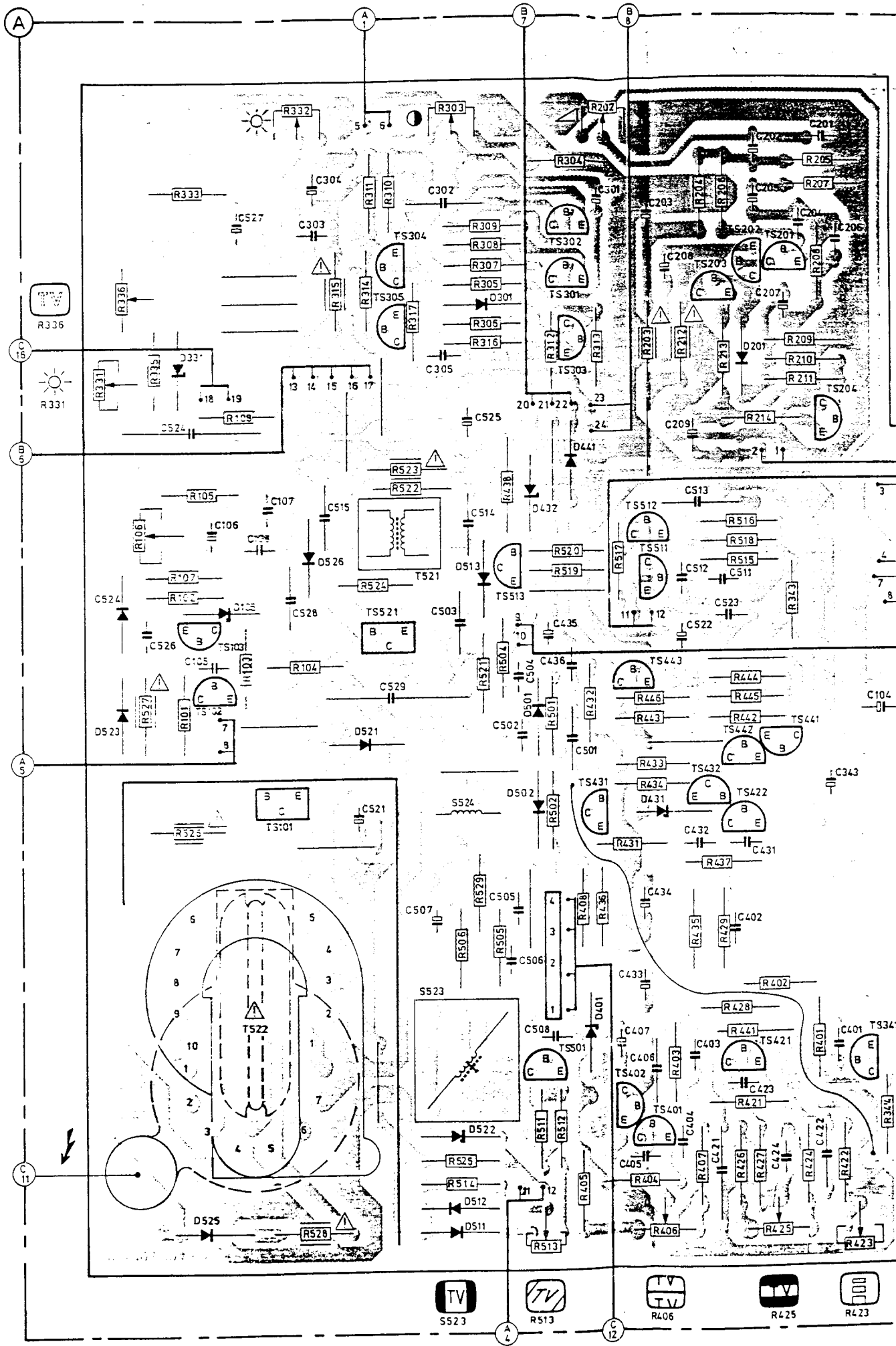

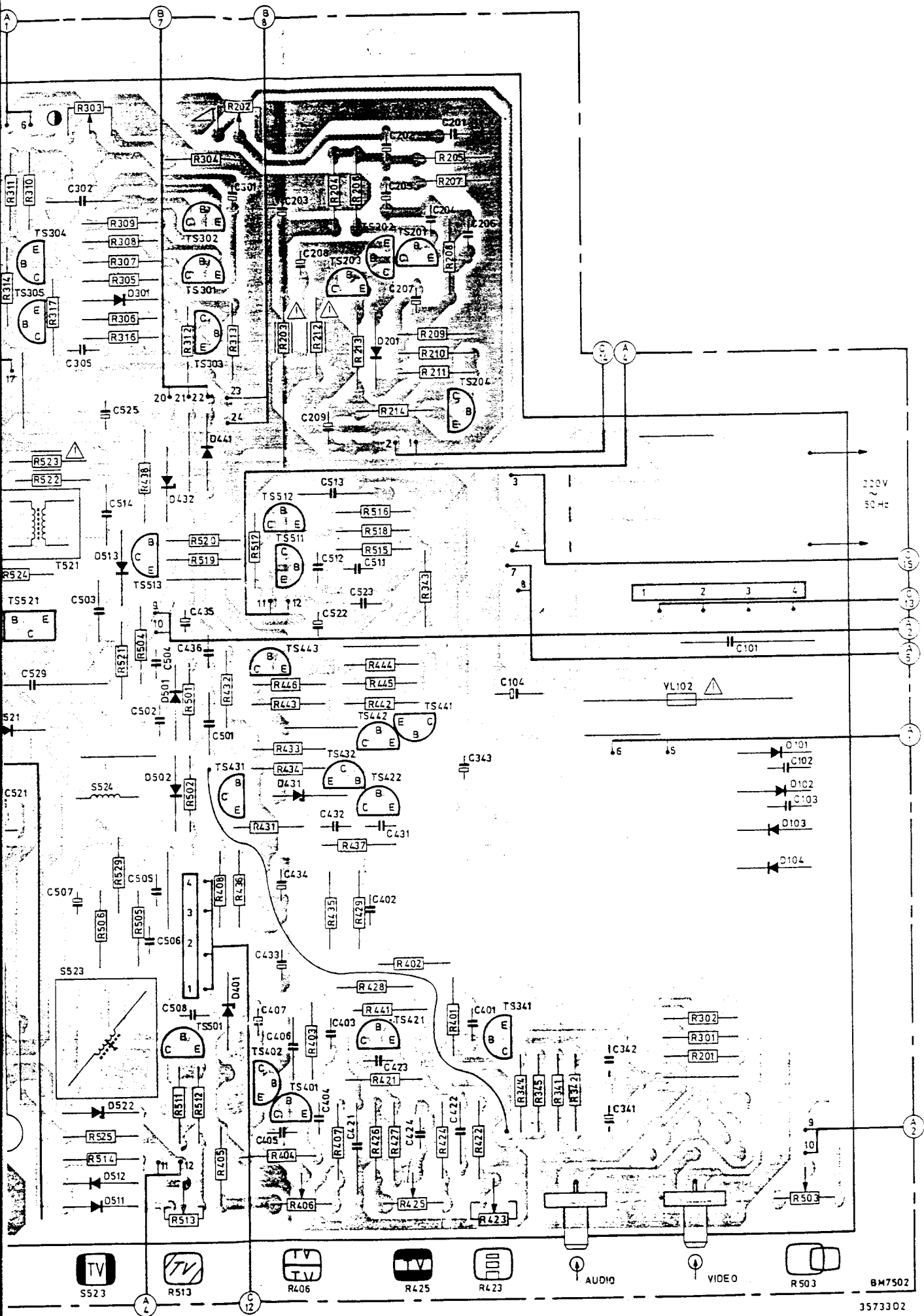

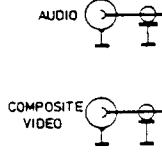
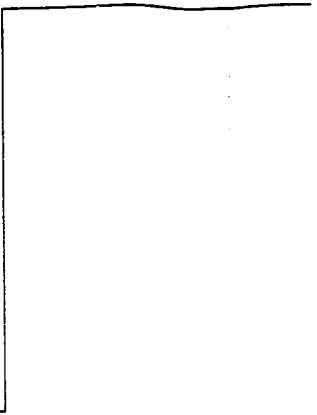
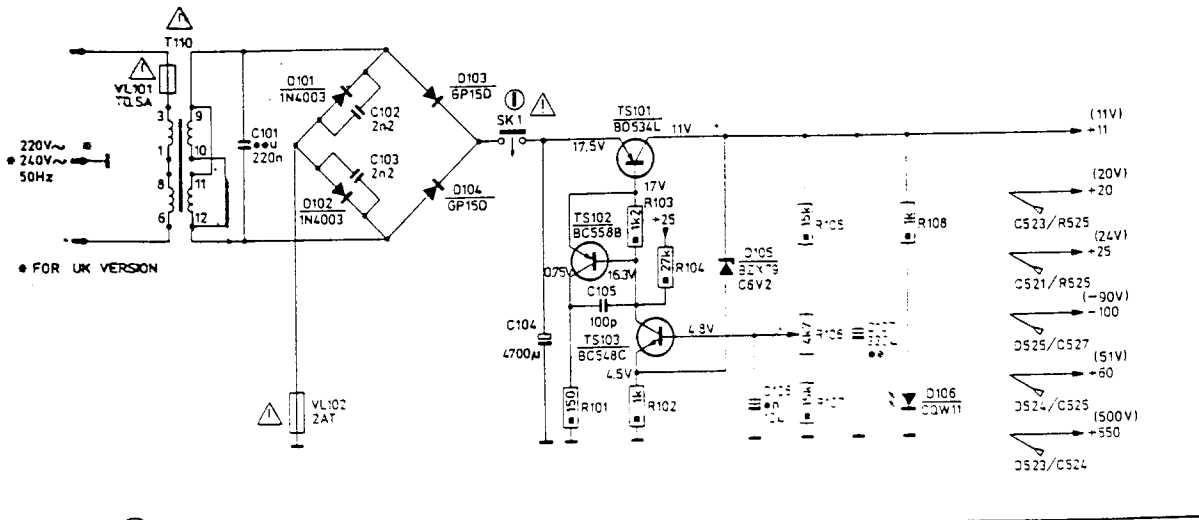

SAFETY RESISTOR
 RESISTENZA DI SICUREZZA
 SFR25 - 0.125W 5%
 CR37 - 0.25W 5-10%
 CERAMIC - CERAMICO
 FLAT - FOIL - PIATTO
 ELECTROLYTIC
 OSCILLOGRAMMI (PM5519)
 REGOLARE L'USCITA VIDEO SU 0.4Vcc
 CON IL GENERATORE SULLA
 SCALA DEI GRIGI

40kΩ/V
 P24111
 MAX MIN.
 e = 16V
 f = 25V
 h = 63V
 j = 100V
 r = 250V
 w = 600V
 OSCILLOGRAMMS (PM5519)
 GENERATOR ON GREY SCALE AND
 VIDEO OUTPUT ADJUST ON 0.4Vcc
 MAX. MIN.

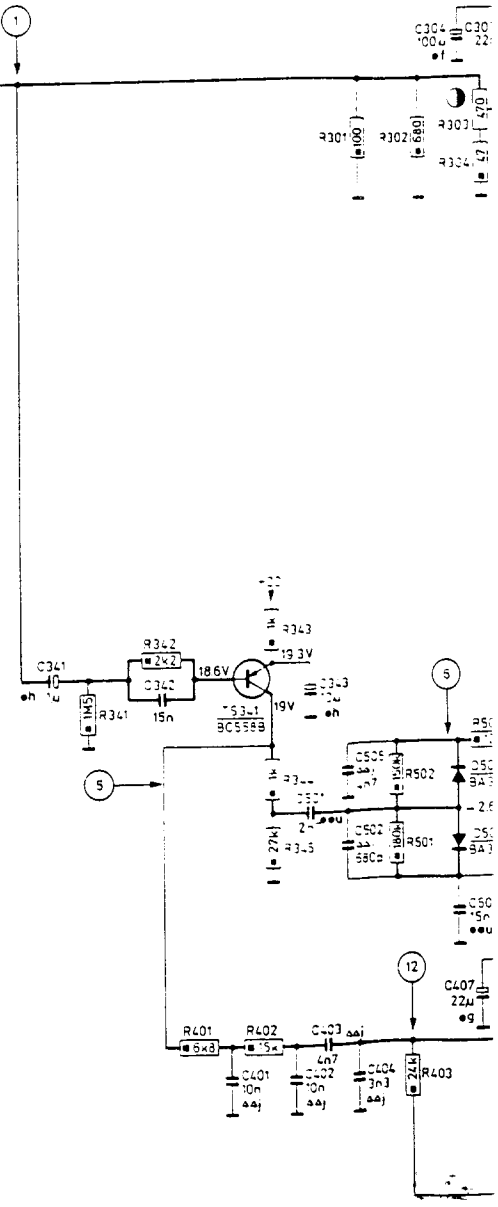
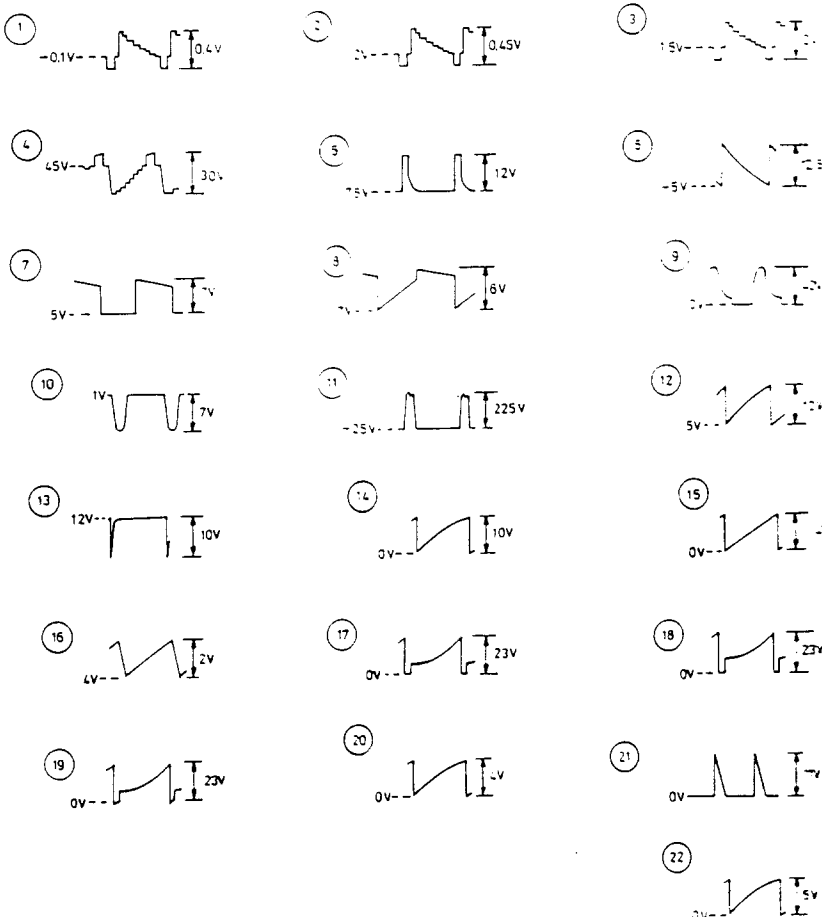

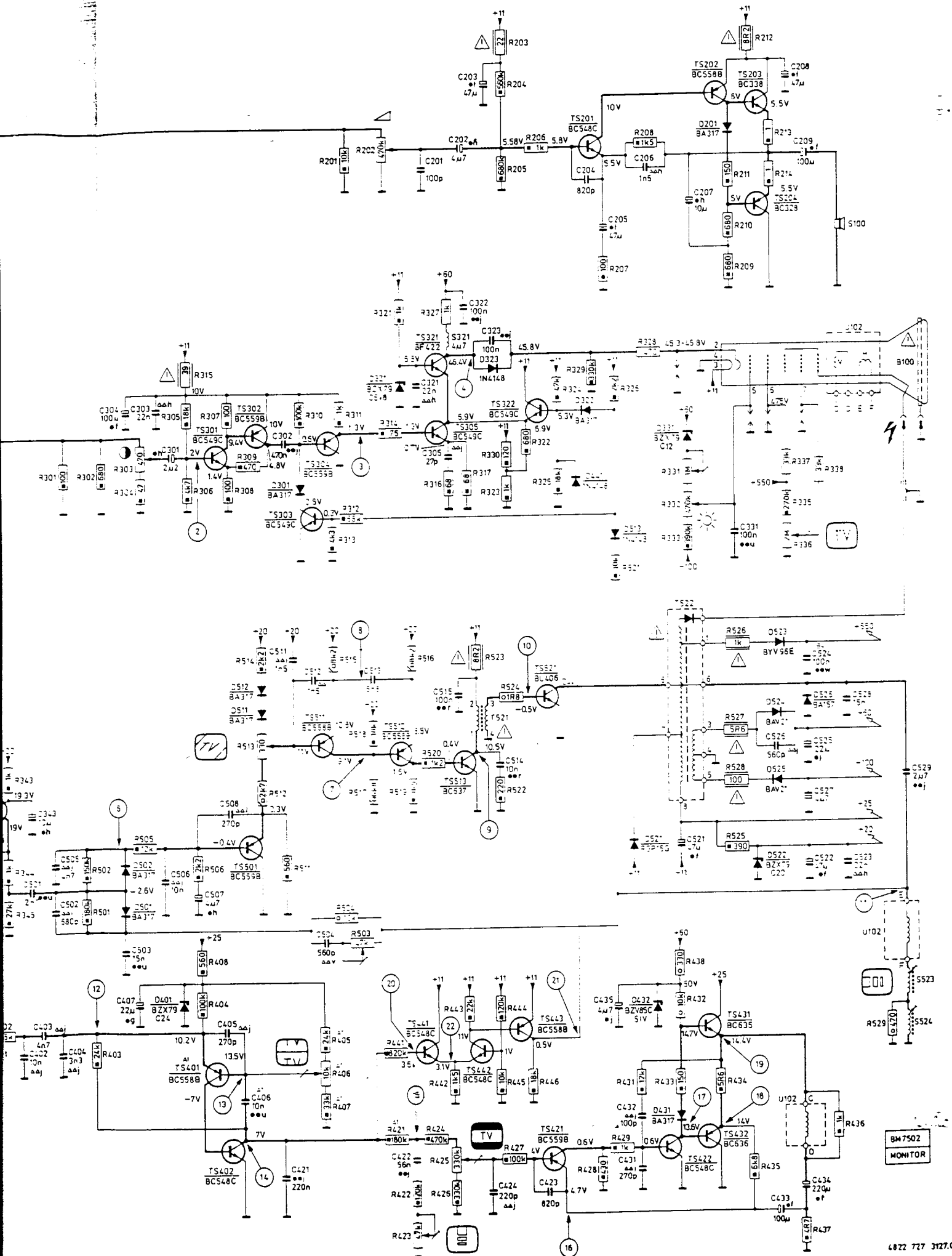

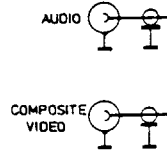
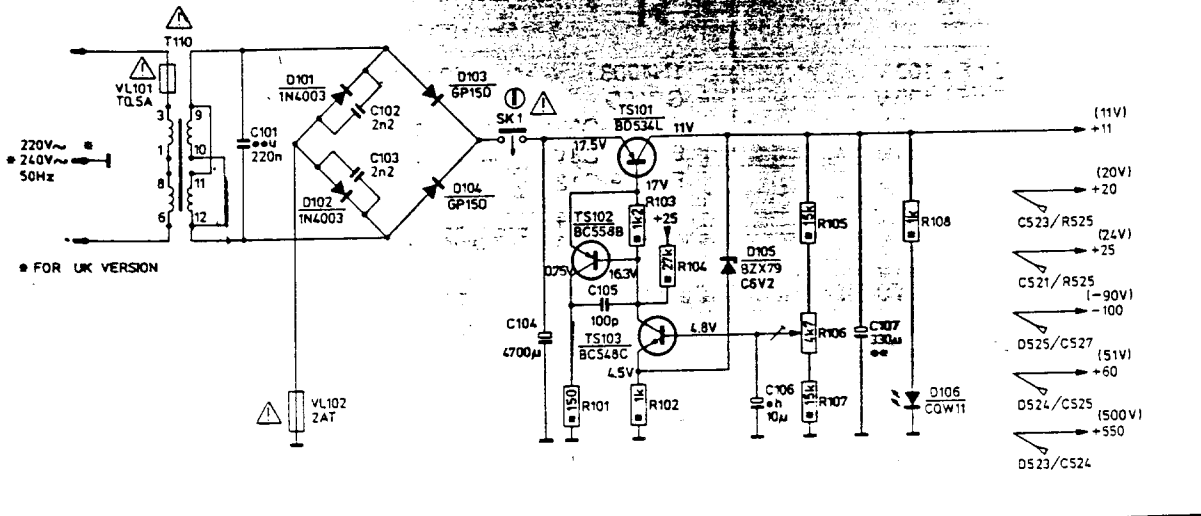

- SAFETY RESISTOR
RESISTENZA DI SICUREZZA
 - SFR25 - 0.125W 5%
 - CR37 - 0.25W 5-10%
 - CERAMIC - CERAMICO
 - FLAT - FOIL - PIATTO
 - ELECTROLYTIC
- OSCILLOGRAMMI: (PM5519)
 REGOLARE L USCITA VIDEO 54 0.4Vcc
 CON IL GENERATORE SULLA
 SCALA DEI GRIGI
- MASSIMO ☀ MASSIMO

- 40kΩ/V (PM2411)
 - MAX. MIN.
- * = 16V
 f = 25V
 h = 63V
 j = 100V
 r = 250V
 w = 600V
- AC
 → DC
- OSCILLOGRAMMS: (PM5519)
 GENERATOR ON GREY SCALE AND
 VIDEO OUTPUT ADJUST ON 0.4Vpp
- MAX. ☀ MAX.

