

ACCEVIEWEN 71761E/71761S	(MAIN:KRT)	SCHEMATICS
SIZE A3	FAB 761E4-E-SCH	REV. 6
DATE 3/07/1996	E	304-101
Project Code:	91.78002.001	Sheet 1 of 5
Prepared By	Reviewed By	Approved By

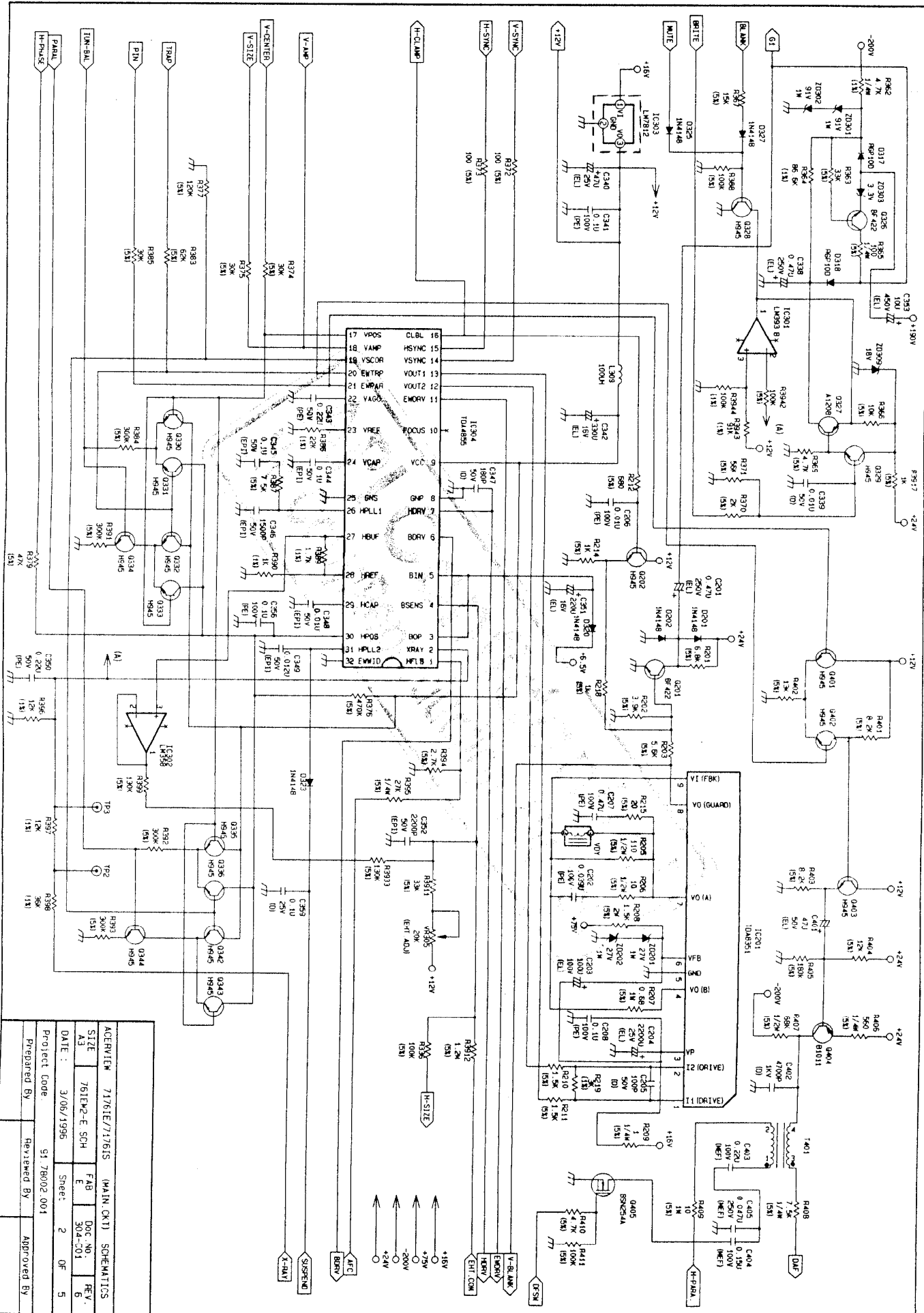

ACREVIEW	7/16/E/7/16/S	(MAIN CKT)	SCHEMATICS	
SIZE	A3	FAB	DOC NO.	REV.
DATE	3/06/1996	E	304-01	6
Project Code	51 78002 001	Sheet	2	OF
Prepared By	Revised By	Approved By		

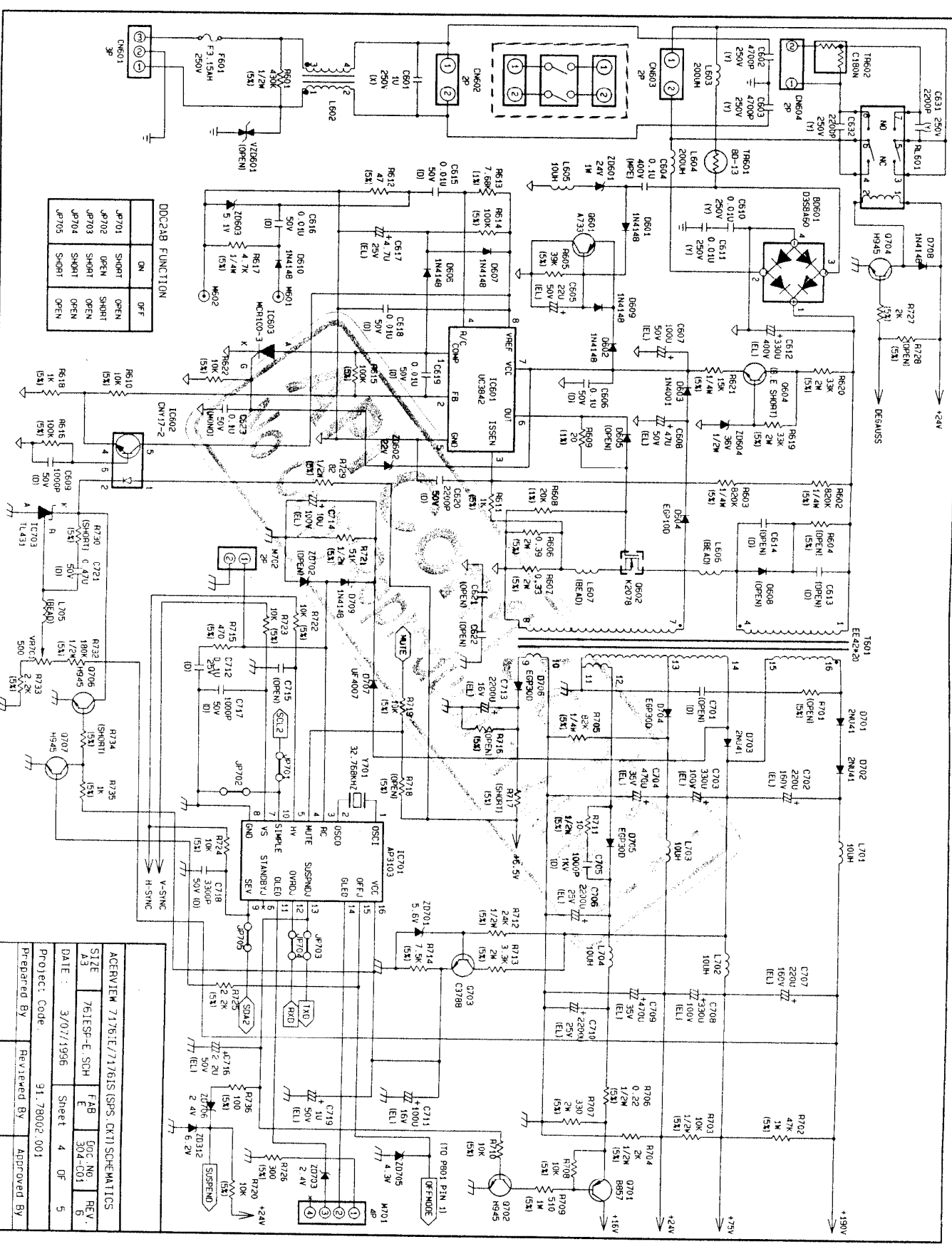

DDC24B FUNCTION

JP701	DN	JP7
JP702	OPEN	JP8
JP703	SHORT	JP9
JP704	SHORT	JP10
JP705	SHORT	JP11

ACERVIEW 7176/E/7176IS (SPS) CKTI SCHEMATICS				
SIZE	761ESF-E-SCH	FAB	DOC. NO.	REV.
DATE	3/07/1996	SHEET	4 OF	5
Prepared By	Reviewed By	Project Code	31.78002.001	
Approved By				

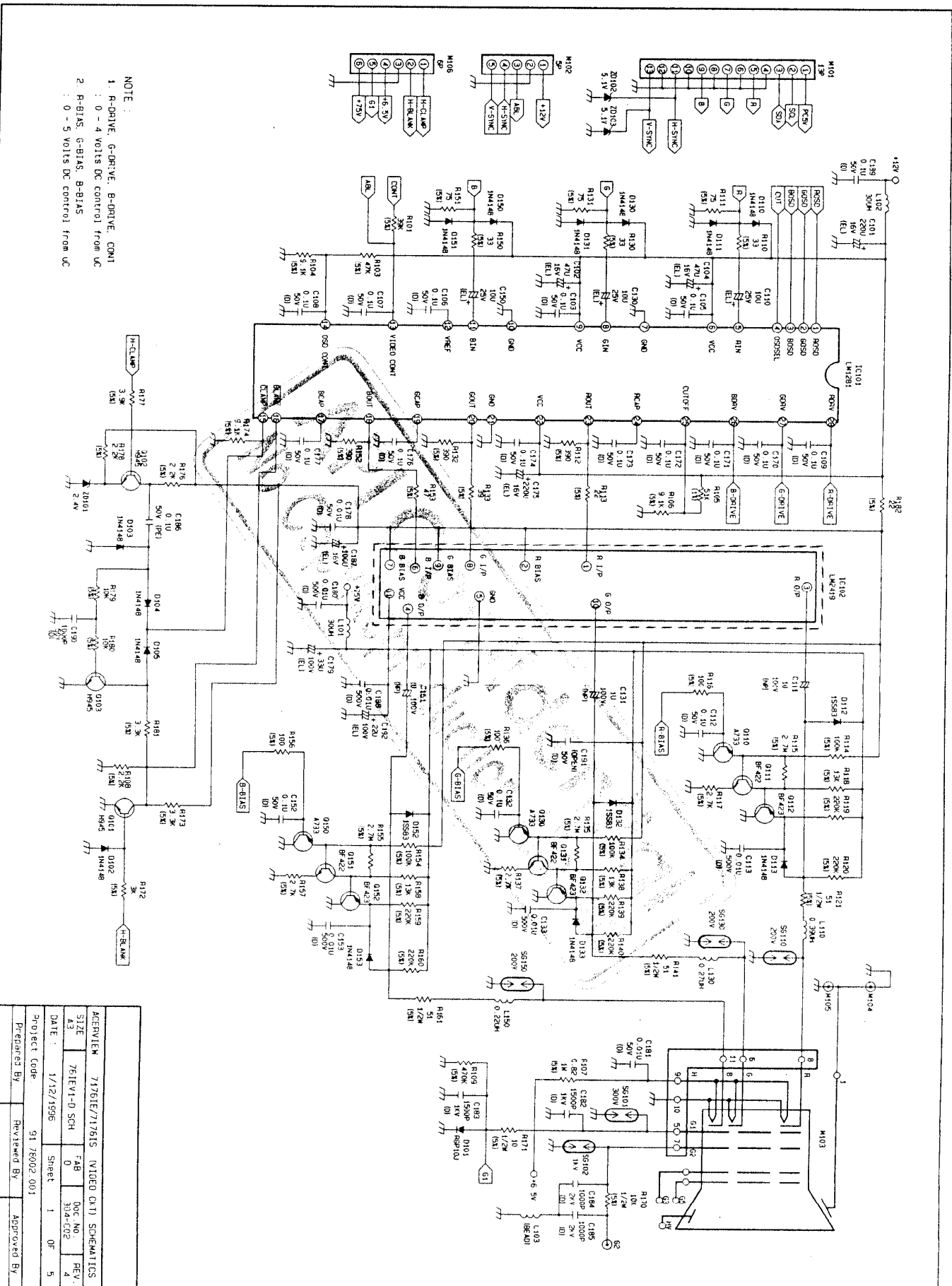

NOTE:  
 1. R-DRIVE, G-DRIVE, B-DRIVE, CONT  
 : 0 - 4 VOLTS DC CONTROL FROM UC  
 2. R-BIAS, G-BIAS, B-BIAS  
 : 0 - 5 VOLTS DC CONTROL FROM UC

ADVERTISEMENT	71761E/71761S	VIDEO (X1)	SCHEMATICS
SIZE	761EVI-D-SCH	FAB	DOC NO
DATE	1/12/1996	REV	30A-C02
Project Code	91 76002 001	Sheet	1 OF 5
Prepared By	Reviewed By	Approved By	

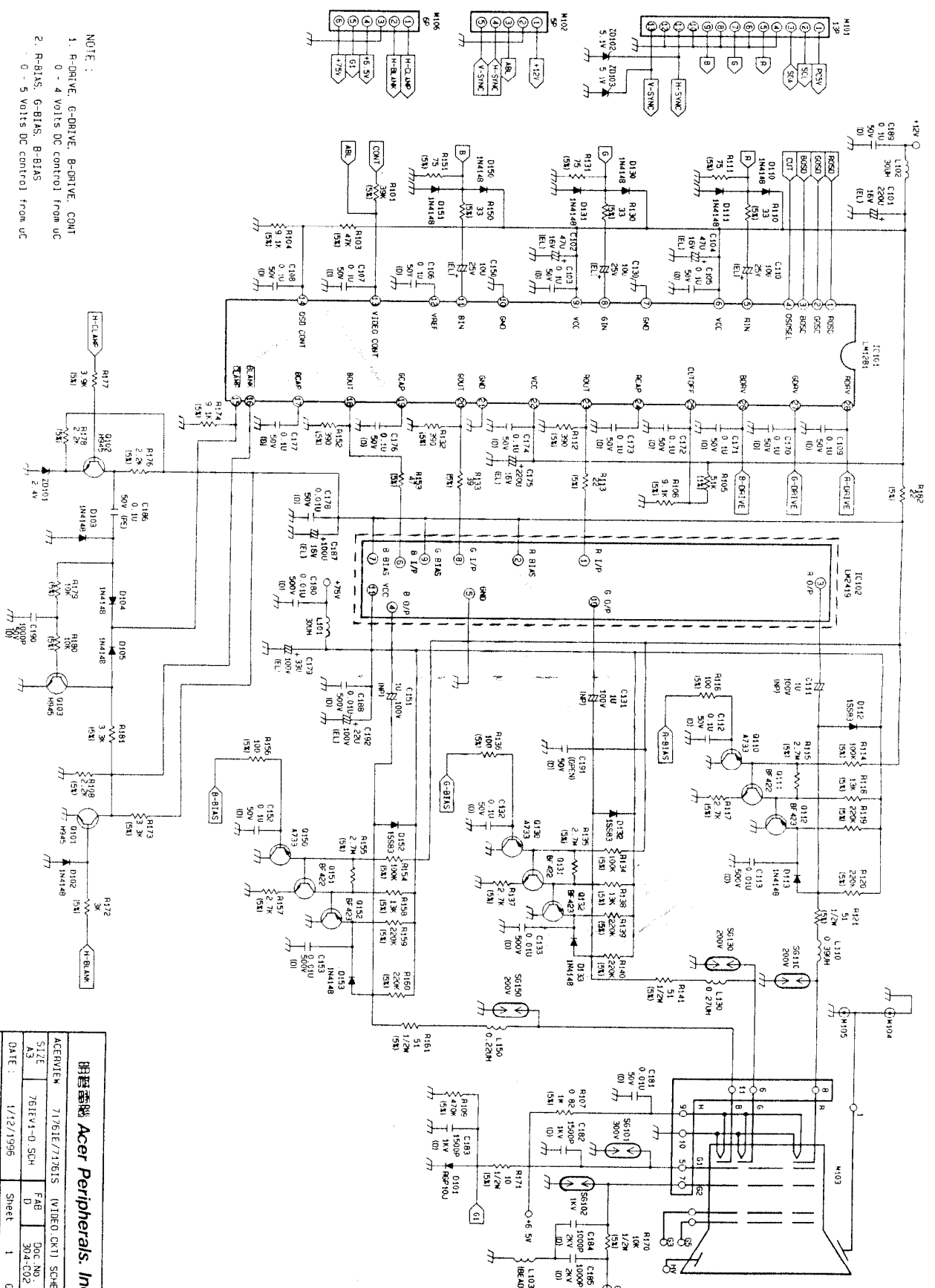

NOTE:  
 1. R-DRIVE, G-DRIVE, B-DRIVE, COMT  
 0 - 4 volts DC control from UC  
 2. R-BIAS, G-BIAS, B-BIAS  
 0 - 5 volts DC control from UC

明基電腦 Acer Peripherals, Inc.

ACBVIEW 71761E/71761S (VIDEO CKT) SCHEMATICS

SIZE A3 761EV-1-D-SCH FAB D DOC NO. REV. 4

DATE: 1/12/1996 SHEET 1 OF 5

Project Code 91-78002-001

Prepared By Reviewed By Approved By

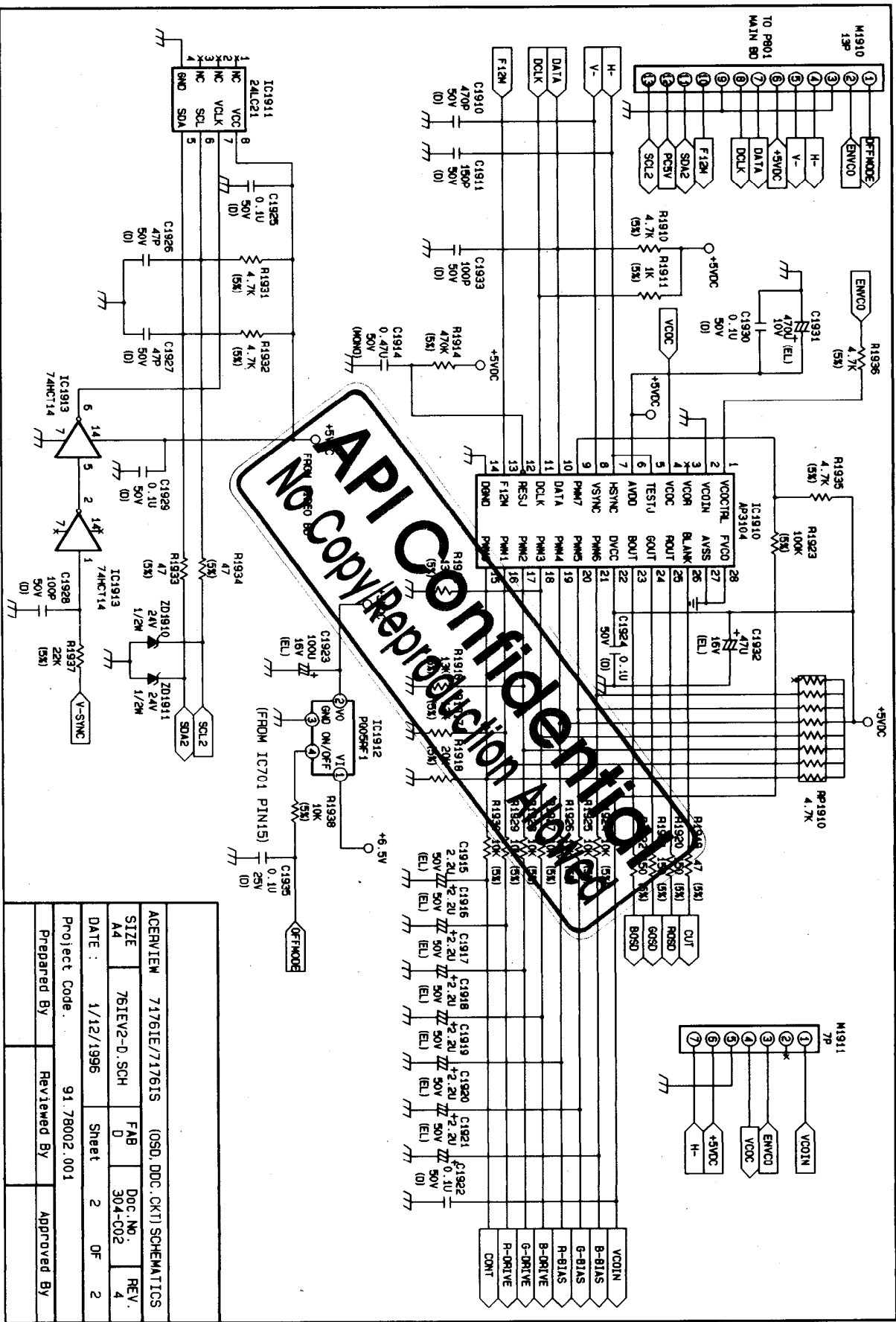

API Confidential  
No Copy/Reproduction Allowed

ACSRVIEW		71761E/71761S		(OSD, DDC, CKT) SCHEMATICS	
SIZE	A4	FAB	761E/2-D.SCH	DOC. NO.	304-C02
DATE	1/12/1996	Sheet	2	OF	2
Project Code	91.78002.001				
Prepared By	Reviewed By	Approved By			

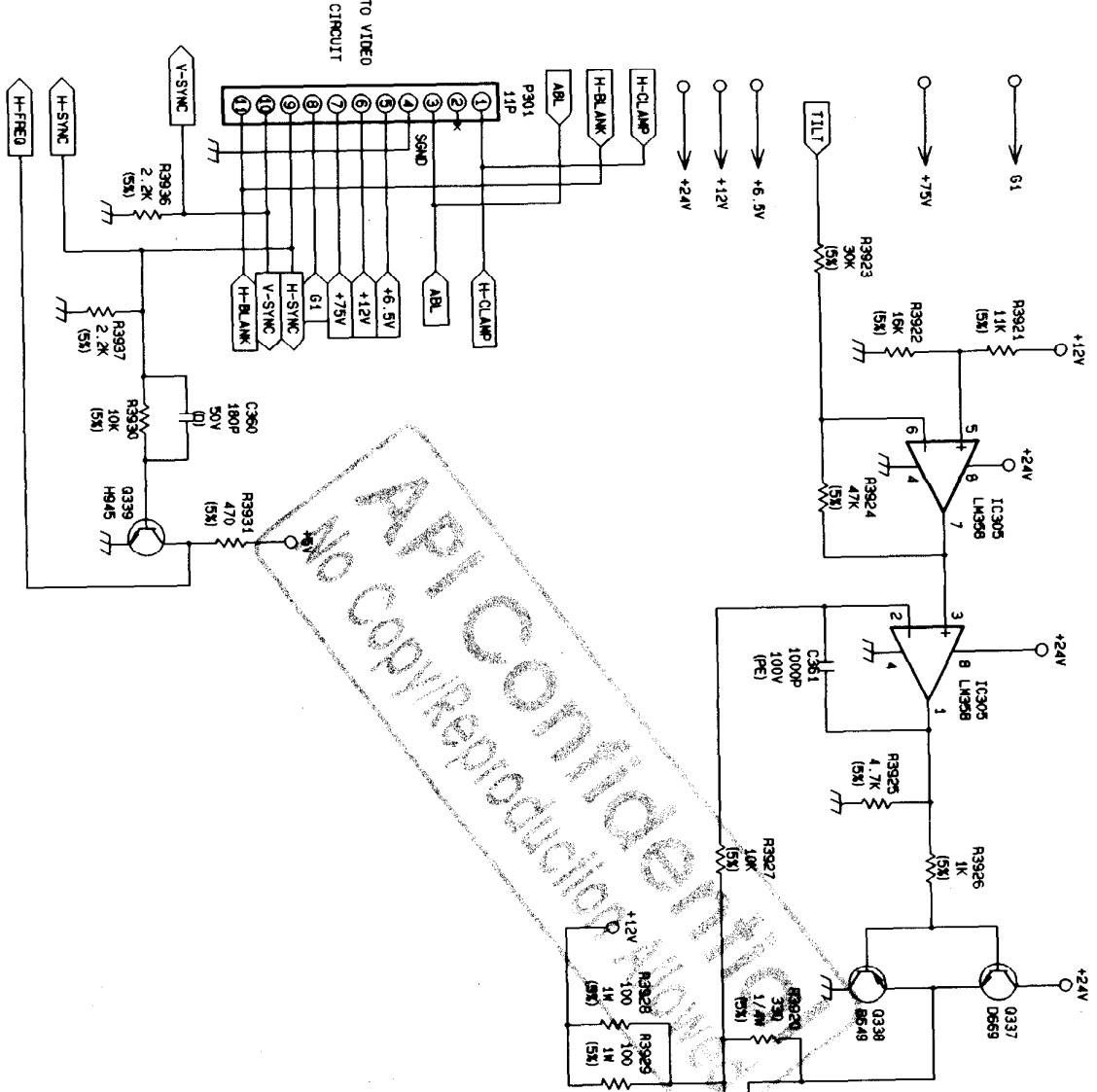

TO VIDEO  
CIRCUIT

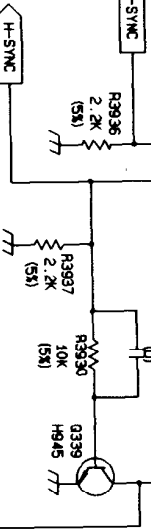
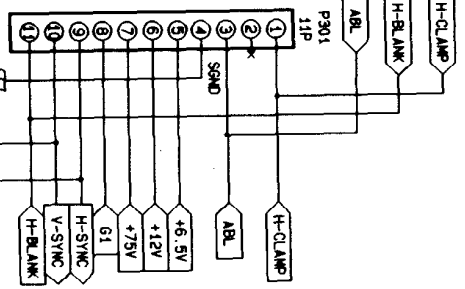

API CONFIDENTIAL  
No Copy/Reproduction Allowed

ACERVIEW		71761E/71761S		(MAIN.CKT)		SCHEMATICS	
SIZE	A4	761E/3-E.SCH	FAB	DOC. NO.	304-001	REV.	6
DATE	3/07/1996		Sheet	3	OF	5	
Project Code.				91.78002.001			
Prepared By		Reviewed By		Approved By			

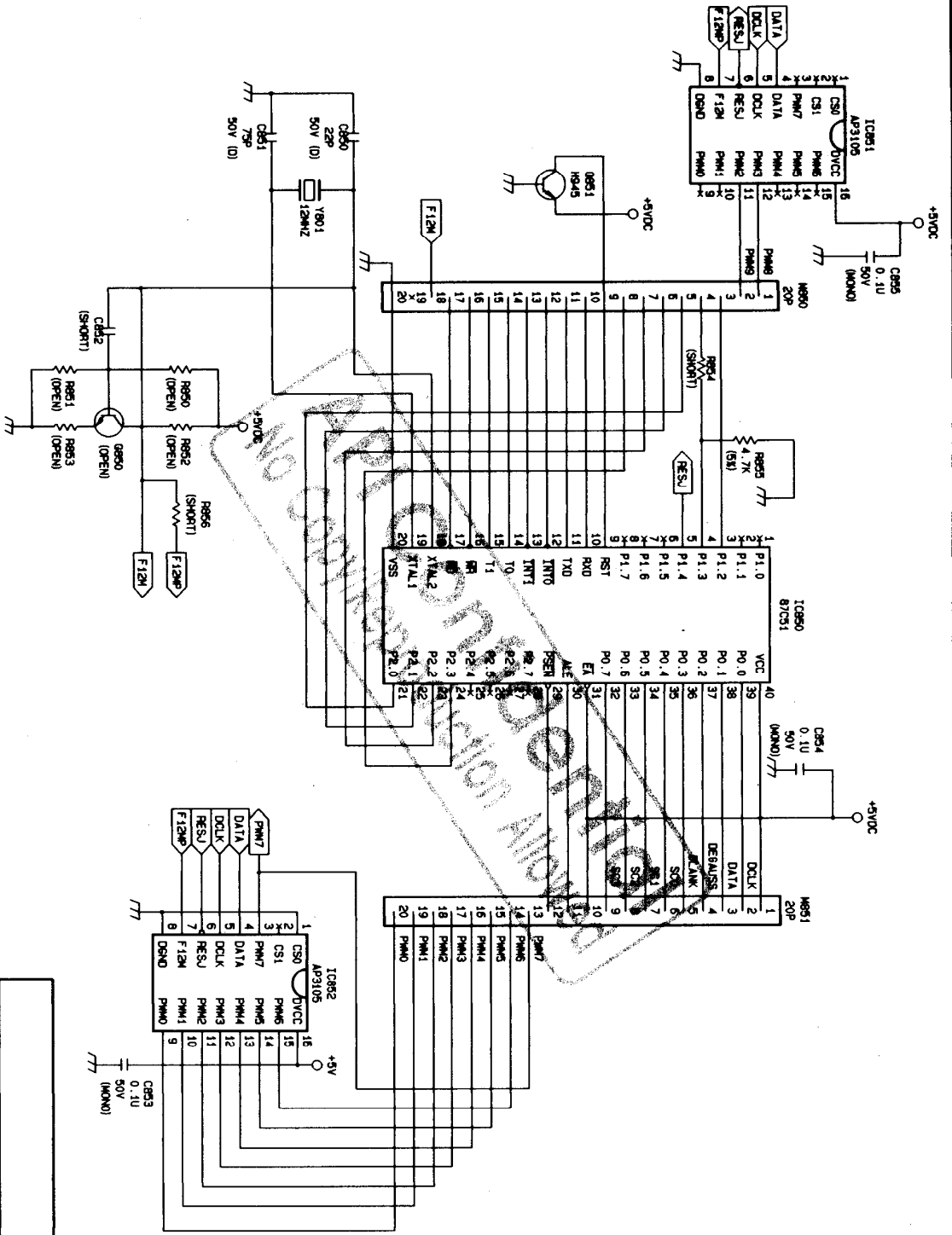

ACERVIEW 71761S (PGM. BD) SCHEMATIC			
SIZE	A4	FAB	REV.
	761SP6S1.SCH	S1	204-C01
DATE	9/1/1995	SHEET	1 OF 1



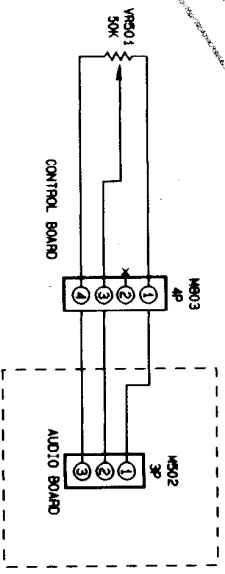
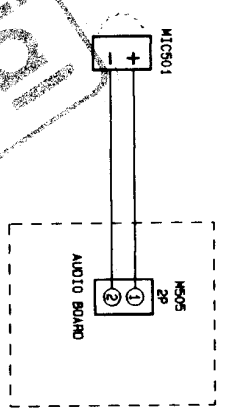
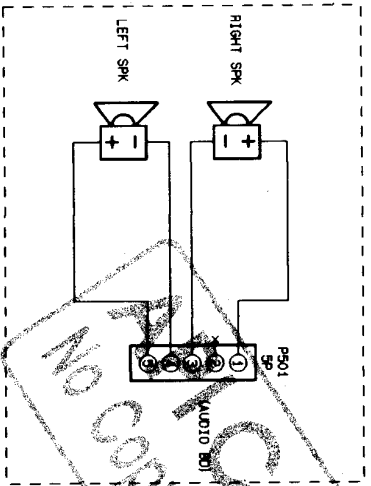
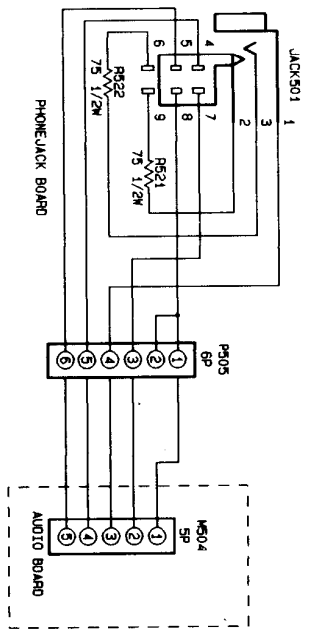

No Copy/Reproduction Allowed  
 Confidential

ACER/VIEW 71761S (PHONEJACK CKT) SCHEMATIC			
SIZE	A4	FAB	REV.
DATE	10/12/1995	SHEET	1 OF 1
	761S/JACK.SCH	304-004	0

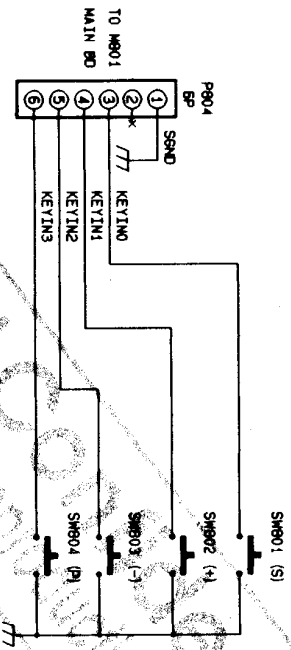

COPYRIGHT © 1995 BY WIRETECH CORPORATION

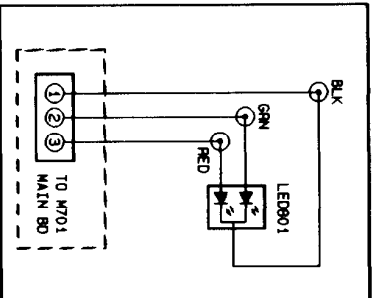

ACERVIEW 71761S (CTRL. CKT) SCHEMATIC			
SIZE	761SCT-A.SCH	FAB	REV.
A4		A	304-C06 1
DATE	11/02/1995	SHEET	1 OF 1

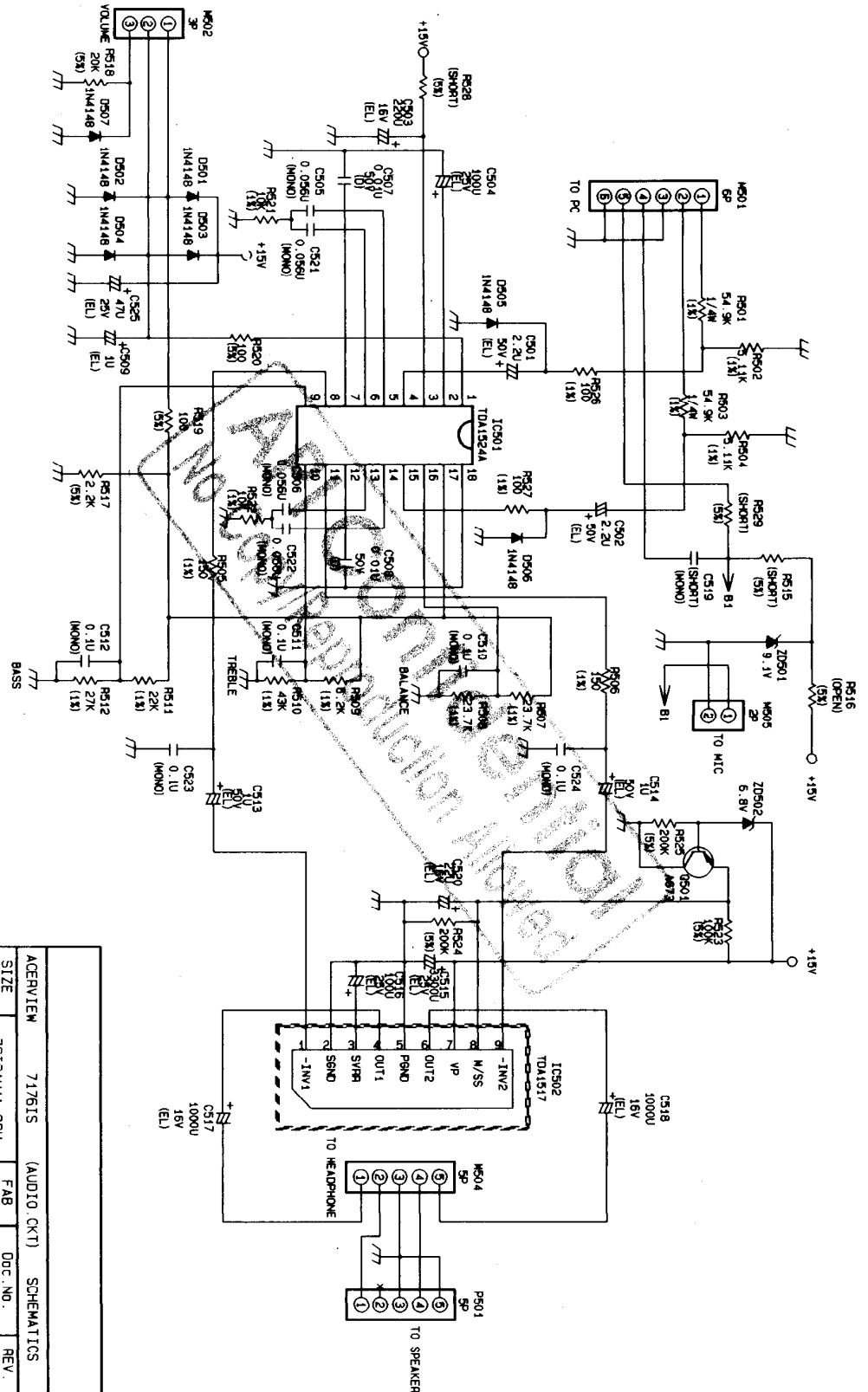

Copyright © 2000 by Electronic Technology Publications, Inc. All rights reserved.

ACERVIEW	71761S	(AUDIO CKT)	SCHEMATICS
SIZE	A4	FAB	Doc. NO. 304-C07
DATE :	3/19/1996	Sheet	1 OF 2
Project Code:	91.79302.001		
Prepared By	Reviewed By	Approved By	

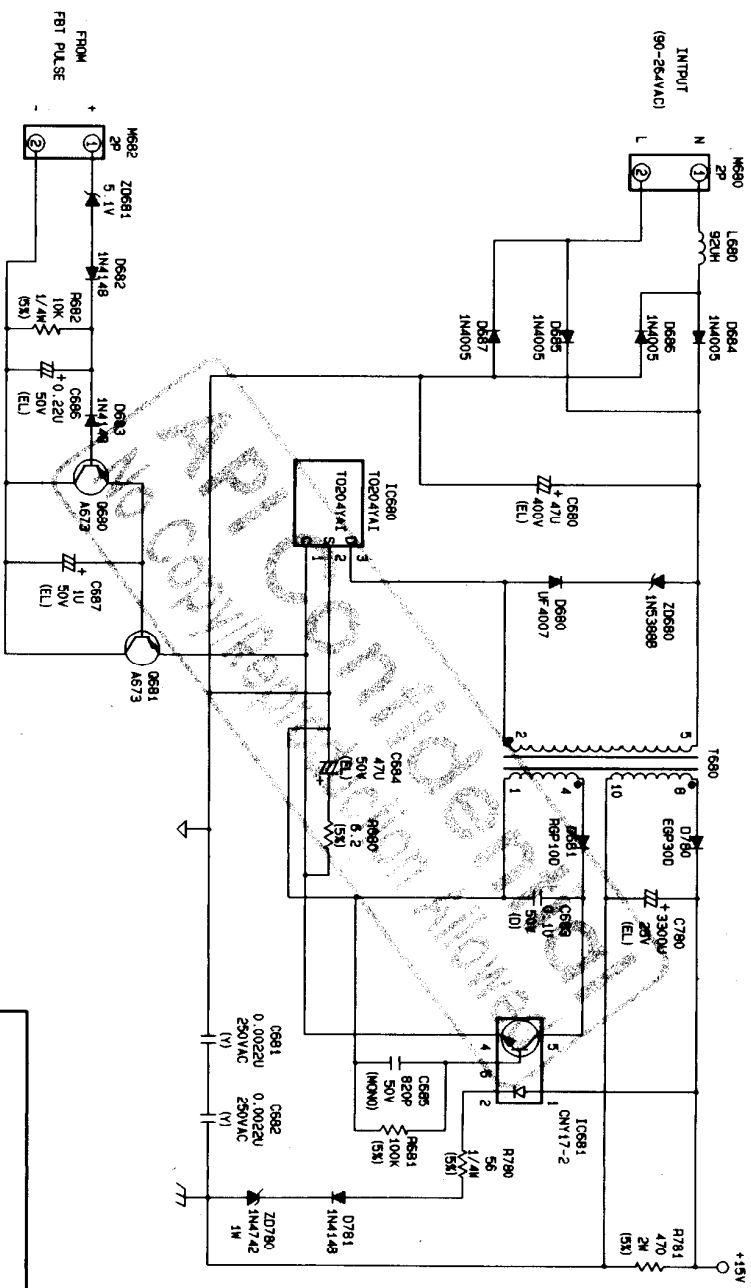

ACERVIEW				71761S (AUDIO POWER BD) SCHEMATICS			
SIZE	761SAUZA.SCH	FAB	DOC. NO.	REV.			
A4		A	304-C07	3			
DATE :	3/18/1996	Sheet	2	OF	2		
Project Code	91.78302.001						
Prepared By	Reviewed By			Approved By			